 **DISPENSE-RITE®**

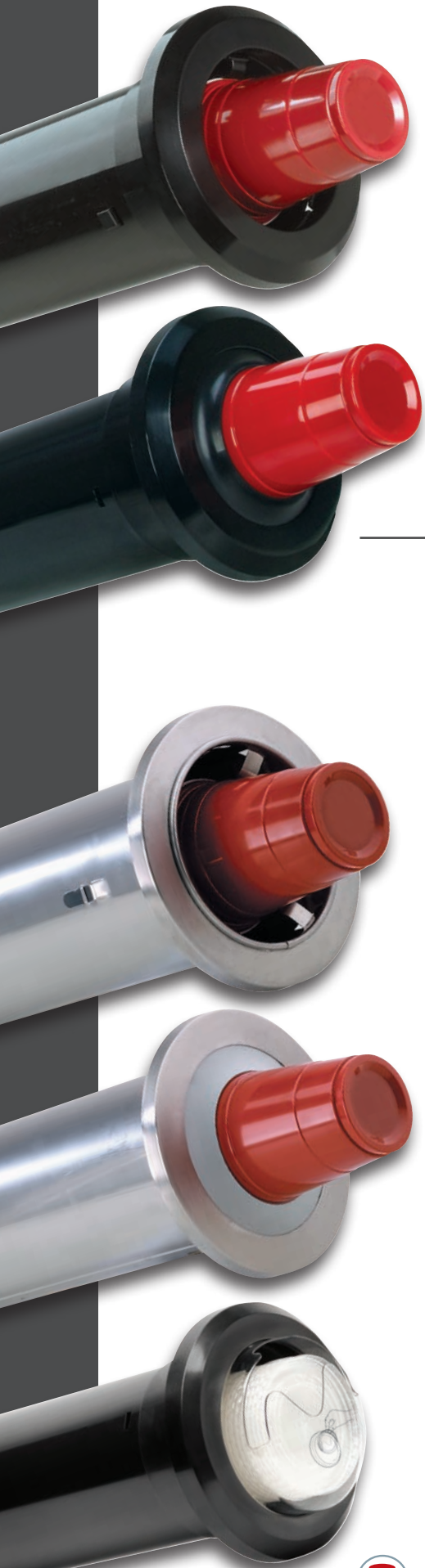

With a 70 year commitment to manufacturing dispensing products for the foodservice industry our expertise ensures correct product selection and complete satisfaction. **DISPENSE-RITE** quality cup dispensers have been installed in tens of thousands of locations around the world; dispensing millions and millions of cups year after year. Products are manufactured to the highest standards in design, materials and construction.

We are committed to achieving complete customer satisfaction through product excellence, personal attention and prompt service. The professional assistance of a **DISPENSE-RITE** representative and the information provided in this catalog are both a reliable source for meeting your present and future dispensing requirements.

Let us introduce you to the world's largest selection of quality dispensing products. We offer a complete selection of products for cups, lids, straws, condiments, napkins, coffee sleeves, flatware, bottles and ice cream cones.

TABLE OF CONTENTS

02 – 03	COMPANY OVERVIEW TABLE OF CONTENTS
04 – 05	CUP & LID DISPENSER PRODUCT OVERVIEW
▽ STL SERIES ABS PLASTIC ONE-SIZE-FITS-ALL ADJUSTABLE CUP DISPENSERS	
06 – 07	STL-2 SERIES ONE-SIZE-FITS-ALL ABS PLASTIC IN-COUNTER ADJUSTABLE CUP DISPENSERS
08 – 09	STL-S SERIES STL-SL SERIES STL-C SERIES ONE-SIZE-FITS-ALL POLYSTYRENE COUNTERTOP CUP DISPENSING CABINETS
▽ SLR SERIES ABS PLASTIC ONE-SIZE-FITS-ALL INTERCHANGEABLE BAFFLE CUP DISPENSERS	
10 – 11	SLR-1 SERIES SLR-2 SERIES ONE-SIZE-FITS-ALL ABS PLASTIC IN-COUNTER INTERCHANGEABLE BAFFLE CUP DISPENSERS
12 – 13	SLR-S SERIES SLR-SL SERIES SLR-C SERIES ONE-SIZE-FITS-ALL POLYSTYRENE COUNTERTOP CUP DISPENSING CABINETS
14 – 15	SLR-R SERIES SLR-C SERIES ONE-SIZE-FITS-ALL STAINLESS STEEL COUNTERTOP CUP DISPENSING CABINETS
16 – 17	MCDC SERIES ONE-SIZE-FITS-ALL STAINLESS STEEL MOBILE CUP DISPENSING CABINETS
▽ ADJ SERIES STAINLESS STEEL ADJUSTABLE CUP DISPENSERS	
18-19	ADJ-1 SERIES ADJ-1.50 SERIES ADJ-2 SERIES ONE-SIZE-FITS-ALL ADJ-3 SERIES STAINLESS STEEL IN-COUNTER ADJUSTABLE CUP DISPENSERS
20 – 21	CTC-R SERIES CTC-L SERIES ONE-SIZE-FITS-ALL STAINLESS STEEL COUNTERTOP CUP DISPENSING CABINETS
22 – 23	CTC-S SERIES CTC-C SERIES CTC-M SERIES ONE-SIZE-FITS-ALL POLYSTYRENE COUNTERTOP CUP DISPENSING CABINETS
24 – 25	CTC-C SERIES ONE-SIZE-FITS-ALL STAINLESS STEEL COUNTERTOP CUP, LID & STRAW DISPENSING CABINETS
▽ BFL SERIES STAINLESS STEEL INTERCHANGEABLE BAFFLE CUP DISPENSERS	
26 – 27	BFL-2 SERIES ONE-SIZE-FITS-ALL BFL-3 SERIES STAINLESS STEEL IN-COUNTER INTERCHANGEABLE BAFFLE CUP DISPENSERS
28 – 29	BFL-R SERIES BFL-L SERIES ONE-SIZE-FITS ALL STAINLESS STEEL COUNTERTOP CUP DISPENSING CABINETS
30 – 31	BFL-S SERIES BFL-C SERIES ONE-SIZE-FITS-ALL POLYSTYRENE COUNTERTOP CUP DISPENSING CABINETS
32 – 33	BFL-C SERIES ONE-SIZE-FITS-ALL STAINLESS STEEL COUNTERTOP CUP, LID & STRAW DISPENSING CABINETS

NEW PRODUCTS

▽ SLR SERIES ABS PLASTIC LID DISPENSERS & STRAW ORGANIZERS

34 – 35 SLR-LID-2 SERIES LID DISPENSERS | SLR-STRAW-2 STRAW ORGANIZERS
SLR-LID-2 SERIES COUNTERTOP LID, CUP & STRAW DISPENSING CABINETS
NLO-STK-1BT | SLR-STK-1BT | LID-STK-1BT | STR-STK-1BT STACKABLE ORGANIZERS

▽ ADJ-NW , ADJ-NS , SFL AND TLD SERIES STAINLESS STEEL SURFACE/STAND MOUNTED DISPENSERS

36 – 37 ADJ-NW SERIES | ADJ-NS SERIES ADJUSTABLE CUP DISPENSERS
TLD SERIES LID DISPENSERS | EZ-3EZ COUNTERTOP STAND

38 – 39 SFL SERIES PORTION CUP & LID DISPENSERS | SFL-STAND SERIES
CTCO SERIES PORTION CUP & LID ORGANIZERS

▽ CUP, LID, STRAW AND CONDIMENT ORGANIZERS - POLYSTYRENE

40 – 41 LID SERIES CUP AND LID DISPENSERS
LCO SERIES | MCD SERIES CUP, LID, STRAW & CONDIMENT ORGANIZERS

▽ LID, STRAW, CONDIMENT AND NAPKIN ORGANIZERS - POLYSTYRENE & STAINLESS STEEL

42 – 43 NLO-1B | WLO-1B | NLO-WVL | NLO-CTVL | MICRO-1
NLS-1BT | WLS-1BT | NSLC-1BT | NLS-1 | WLS-1 LID, STRAW AND CONDIMENT ORGANIZERS

44 – 45 NLO SERIES LID, STRAW, CONDIMENT, FLATWARE AND NAPKIN ORGANIZERS
CTBH SERIES COUNTERTOP BOTTLE HOLDERS
CTSH SERIES | SWCH-1BT | VSCH SERIES FLATWARE AND CONDIMENT ORGANIZERS

▽ CUP, LID, STRAW AND CONDIMENT ORGANIZERS - POLYSTYRENE

46 - 47 CLCO SERIES | RCLO SERIES COUNTERTOP CUP & LID ORGANIZERS
CTVH SERIES COUNTERTOP CONDIMENT ORGANIZERS | SLR-SCL SERIES CUP, LID & STRAW

▽ WR-SERIES COUNTERTOP CUP, LID, CONDIMENT AND BOTTLE ORGANIZERS - WIRE FORM

48 – 49 WR-CT SERIES | WR SERIES CUP & LID DISPENSERS

50 - 51 WR-CT-OVRHD | WR-CC-22 | WR-COND SERIES | WR-BOTL SERIES ORGANIZERS

▽ CUP, LID, STRAW AND CONDIMENT ORGANIZERS - POLYSTYRENE

52 - 53 PL-CT SERIES CUP, LID & CONDIMENT DISPENSING CABINETS
HVCD SERIES CONDIMENT ORGANIZERS | TLO-DL SERIES DOME LID DISPENSERS

▽ LID DISPENSERS - STAINLESS STEEL, POLYSTYRENE & CLEAR ACRYLIC

54 – 55 TLO SERIES LID & STRAW DISPENSING CABINETS

56 – 57 CTLD SERIES CUP, LID AND STRAW ORGANIZERS | TSD-1S STRAW HOLDER
CTHL SERIES | MSH-1 | MLD SERIES | MOPU-1B

▽ LID, STRAW AND NAPKIN BUILT-IN ORGANIZERS - POLYSTYRENE & ACRYLIC

58 – 59 FMVL SERIES | FMVDL-3 | FMVS-1BT | FMVS-1 | FMN-1BT POLYSTYRENE ORGANIZERS
FML SERIES | FMC SERIES | FMN SERIES ACRYLIC ORGANIZERS

▽ UNDER COUNTER BRACKETS AND BUILT-IN FLUSH MOUNT PRODUCTS - POLYSTYRENE

60 – 61 UCMB SERIES UNDER COUNTER CUP DISPENSER MOUNTING BRACKETS
FMSH SERIES FLATWARE ORGANIZERS | FMVS SERIES STRAW ORGANIZERS

62 – 63 FMTD SERIES TRASH DOORS | FMRD SERIES RECYCLING DOORS
FMT-1BT TISSUE DISPENSER | FMB-1BT BAG ORGANIZER | TTC SERIES TRASH CHUTES

▽ NAPKIN DISPENSERS, CONDIMENT ORGANIZERS, TRASH CHUTES - STAINLESS STEEL

64 – 65 CMND SERIES | TT SERIES | CT SERIES NAPKIN DISPENSERS
TCD SERIES CONDIMENT HOLDERS | TSD-1C STRAW HOLDER | TCD SERIES TRASH CHUTES

▽ CUP, LID, STRAW, CONDIMENT AND COFFEE SLEEVE DISPENSERS - POLYSTYRENE

66 – 67 PCH-4B COUNTERTOP & SURFACE MOUNT PERSONAL BEVERAGE ORGANIZER
VCO SERIES MULTI-PURPOSE ORGANIZERS
GFBO-4BT | FDL-3 | ADL-3 | SLV SERIES COFFEE SLEEVE DISPENSERS

▽ ICE CREAM CONE DISPENSERS AND CONE STANDS

68 – 69 BCDS-BFL BOXED CONE DISPENSER | CTCD-3BT CONE DISPENSER | 705-DS CONE DISPENSER
GFCD SERIES | CSG-5L | CTSC SERIES CONE HOLDERS | TD-4 TOPPING DISPENSER

▽ IN-COUNTER CUP DISPENSER SPECIFICATIONS - WARRANTY STATEMENT - TERMS & CONDITIONS

70 – 71 PRODUCT SPECIFICATIONS FOR IN-COUNTER CUP DISPENSERS
LIMITED WARRANTY STATEMENT | TERMS AND CONDITIONS | CONTACT INFO

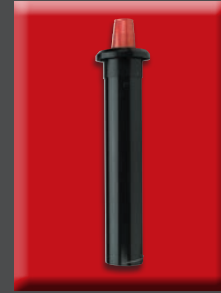

SLR-1 Series, pages 10-11



MDCD Series, pages 16-17



SLR-LID Series, pages 34-35



SLR-SCL-1BT, page 47

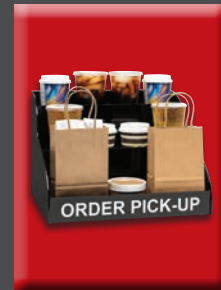

MOPU-1B, page 57

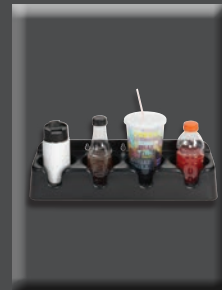

PCH-4B, page 66



MANUFACTURED BY:

Diversified Metal Products, Inc.
2205 Carlson Drive
Northbrook, IL 60062

TOLL-FREE

800-772-2877

PHONE

847-753-9595

FAX

847-753-9648

WEBSITE

www.dispense-rite.com

THE *RITE* DISPENSER FOR EVERY APPLICATION

PRECISION ADJUSTMENT CLIPS

INTERCHANGEABLE SILICONE BAFFLES

ONE-SIZE-FITS-ALL

ABS PLASTIC CONSTRUCTION

STAINLESS STEEL CONSTRUCTION

NSF LISTED

DISPENSE-RITE quality cup dispensers are offered with three alternative dispensing mechanisms in either ABS plastic or stainless steel.

STL Series and ADJ Series cup dispensers utilize a precision three clip adjustment mechanism to ensure the exacting fit for a particular cup or container size.

SLR Series and BFL Series cup dispensers utilize an interchangeable baffle gasket system for operators preferring the simplicity of a self-adjusting dispenser.

SLR-LID Series lid dispensers utilize a polycarbonate front cover to provide lid dispensing simplicity with no adjustment required.

Dispensers are provided with calibrated compression springs and require no rear fabrication for mounting. All models are NSF Listed.

STL SERIES PAGES 06–09



STL SERIES ABS PLASTIC ADJUSTABLE CUP DISPENSERS

Our exclusive precision adjustment mechanism allows simple and fast adjustment of these dispensers to accommodate a range of cup sizes from 8 oz. to 44 oz. Quality ABS plastic construction provides an economical dispensing solution. Innovative design allows the dispenser to be easily adjusted in the counter without the use of tools.

DISPENSE-RITE
simple and fast
precision adjustment
mechanism



SLR SERIES PAGES 10–17



SLR SERIES ABS PLASTIC INTERCHANGEABLE BAFFLE CUP DISPENSERS

Our interchangeable baffle system accommodates a full range of cup sizes from 4 oz. to 44 oz. Quality ABS plastic construction provides an economical dispensing solution. Innovative design allows the baffle to be easily replaced without removing from the counter. No adjustment is required with any of the SLR Series interchangeable baffle cup dispensers.

DISPENSE-RITE
interchangeable
baffle gasket
system



ADJ SERIES PAGES 18–25



DISPENSE-RITE
exclusive spring-clip
precision adjustment
mechanism

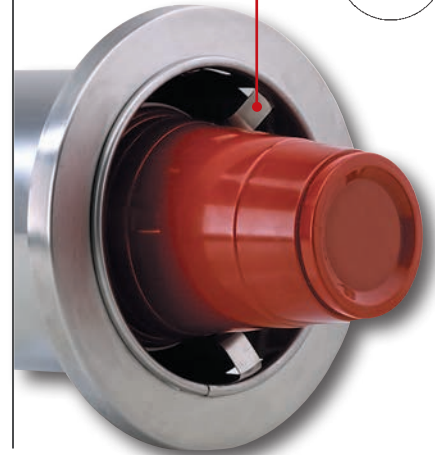

ADJ SERIES STAINLESS STEEL ADJUSTABLE CUP DISPENSERS

Our exclusive precision adjustment mechanism allows simple and fast adjustment of these dispensers to accommodate a full range of cup sizes from 4 oz. to 64 oz. This unique dispenser design utilizes three stainless steel spring clips to combine a full range of adjustment with long-term cup dispensing reliability.

BFL SERIES PAGES 26–33



DISPENSE-RITE
interchangeable
baffle gasket
system

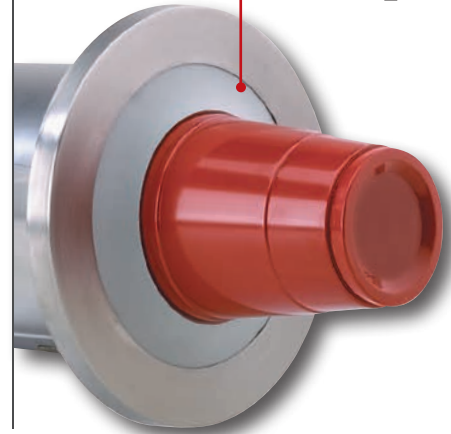

BFL SERIES STAINLESS STEEL INTERCHANGEABLE BAFFLE CUP DISPENSERS

Our interchangeable baffle system accommodates a full range of cup sizes from 8 oz. to 64 oz. The silicone rubber baffles are made from the highest quality materials available. No adjustment is required with any of the BFL Series interchangeable baffle cup dispensers.

SLR-LID SERIES PAGES 34-35



DISPENSE-RITE
lid dispenser
design requires
no adjustment



SLR-LID SERIES ABS PLASTIC SPRING LOADED LID DISPENSERS

Lid dispensers are designed to combine simplicity with dependability for long-term reliability and maximum cost savings. This sanitary beverage lid dispenser requires no adjustment and is available for a variety of in-counter and countertop applications. Lid stacks are enclosed to protect from potential contamination due to spills, splashes and sneezes.

PRECISION ADJUSTMENT DISPENSING FLEXIBILITY

ABS PLASTIC CONSTRUCTION

STL SERIES ONE-SIZE-FITS-ALL IN-COUNTER ADJUSTABLE CUP DISPENSERS

DISPENSE-RITE STL Series cup dispensers feature quality ABS plastic construction combined a simple and fast tool free adjustment mechanism to adjust for cup sizes ranging from 8 oz. to 44 oz.

A calibrated compression spring ensures one at a time dispensing in horizontal, angled or vertical mounting positions. The integrated mounting collar fully supports the dispenser in horizontal, angled or vertical mounting positions; no additional support is necessary. All models are NSF listed.

DISPENSE-RITE
simple and fast
precision adjustment
mechanism

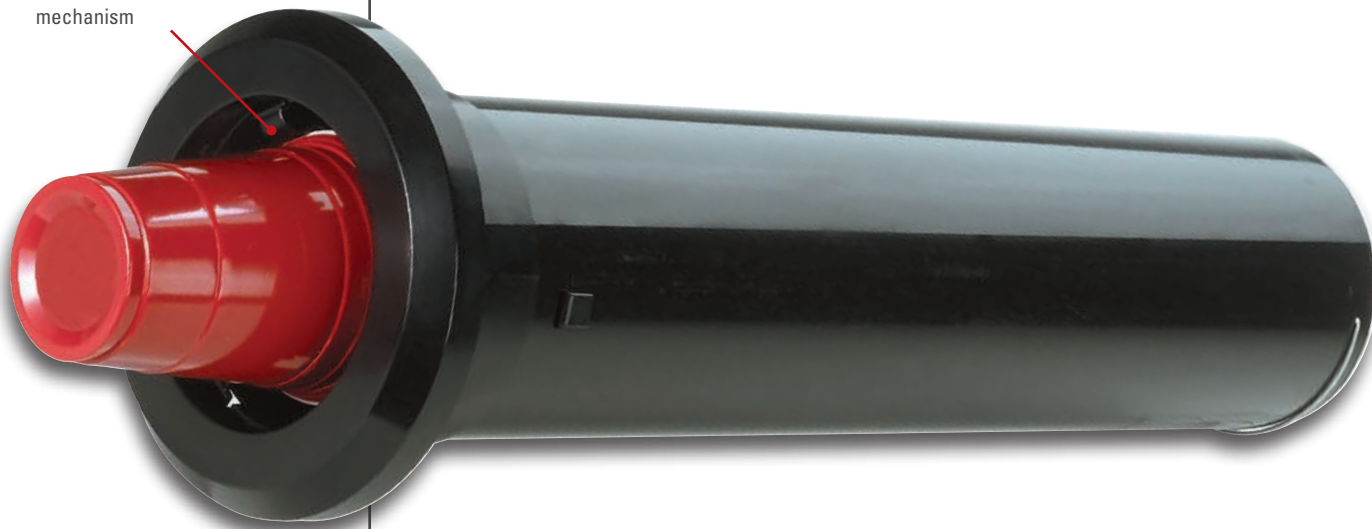

DISPENSE-RITE's precision three clip adjustment mechanism allows the dispenser to be adjusted without using hand tools or removing from the counter. This dispenser offers simple and fast adjustment for a full range of cup sizes.



The **STL-2** is a **One-Size-Fits-All** model that offers maximum dispensing flexibility. This unit is designed to accommodate a variety of 8 oz. to 44 oz. paper, plastic or foam cups with rim diameters ranging in size from 3 1/8"–4 1/2". This model comes in three under counter lengths: 22", 17" and 28". The STL-2 models require a 5/4" hole cut-out.



Model Number	Cup Rim Diameter Range	Under Counter Length	Ring Bezel Diameter	Mounting Hole Cut-Out
STL-2	3 1/8"–4 1/2"	22"	7 1/8"	5 1/4"
STL-2S	3 1/8"–4 1/2"	17"	7 1/8"	5 1/4"
STL-2L	3 1/8"–4 1/2"	28"	7 1/8"	5 1/4"

**STL-2, STL-2S AND STL-2L ONE-SIZE-FITS-ALL
IN-COUNTER ADJUSTABLE CUP DISPENSERS**

These dispensers accommodate a variety of 8 oz. to 44 oz. paper, plastic or foam cups with rim diameters ranging in size from 3 1/8" – 4 1/2". The STL-2 models require a 5 1/4" hole. With three under counter lengths to choose from the STL-2 cup dispenser can be ordered to suit your particular installation requirements.



STL-2 22" UNDER COUNTER LENGTH



STL-2S 17" UNDER COUNTER LENGTH



STL-2L 28" UNDER COUNTER LENGTH

- Models above ship with 2 different compression springs: "F" & "P". See spring configuration chart in upper right for more details.
- Ounce capacities are provided for reference only. Always verify cup rim diameter prior to ordering.

Spring Configurations ▽

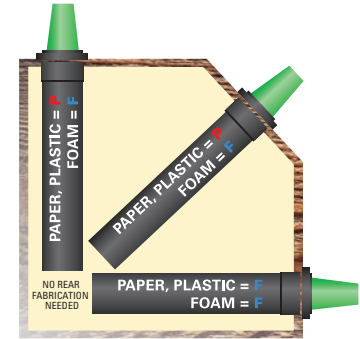

Cup Type	Position	Spring
Foam Cups	: Any Position	: F Spring
Paper Cups	: Horizontal	: F Spring
Plastic Cups	: Horizontal	: F Spring
Paper Cups	: Angled	: P Spring
Plastic Cups	: Angled	: P Spring
Paper Cups	: Vertical	: P Spring
Plastic Cups	: Vertical	: P Spring

Dispensers ship with both the "F" and "P" compression springs. Single spring models are available; see price list for additional information.

Color Ring Bezels ▽

Optional colored ring bezels are available in this popular color:



- SILVER SATIN (stainless faux finish)

Under Counter Bracket ▽

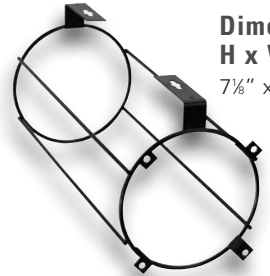

**Dimensions
H x W x D**
7 1/2" x 6" x 15 1/4"

The optional **STL-2-SMB** wire surface mount bracket mounts to any flat surface or wire shelf and allows you to mount a STL-2 cup dispenser in horizontal, vertical or angled positions. Maximum counter lip is 1/2".

GREAT FOR MOUNTING IN-COUNTER CUP DISPENSERS UNDER THE COUNTER



UCMB-2BT

The optional UCMB-2BT under counter mounting bracket is shown here with two STL-2 Series in-counter cup dispensers. UCMB Series mounting brackets are available for the installation of one, two or three in-counter cup dispensers. See page 60 for complete product specifications on the UCMB Series.

ABS PLASTIC CONSTRUCTION

▽ ONE-SIZE-FITS-ALL CUP DISPENSING CABINETS

BLACK POLYSTYRENE CONSTRUCTION



STL-S-2BT



STL-S-3BT



STL-S-4BT

The **STL-S Series** Countertop Cup Dispensing Cabinets feature STL-2 cup dispensers combined with a durable and stylish polystyrene cabinet.

Cabinets dispense a variety of 8 oz. to 44 oz. paper, plastic or foam cups with rim diameters ranging in size from 3 1/8" – 4 1/2".

Model Number	Number of STL-2 Dispensers	Cup Sizes	Cup Rim Diameter Range	Cabinet Dimensions H x W x D
STL-S-2BT	2	8 to 44 oz.	3 1/8" – 4 1/2"	16 1/4" x 8" x 23"
STL-S-3BT	3	8 to 44 oz.	3 1/8" – 4 1/2"	24 1/4" x 8" x 23"
STL-S-4BT	4	8 to 44 oz.	3 1/8" – 4 1/2"	32 1/4" x 8" x 23"



STL-SL-2BT



STL-SL-3BT



STL-SL-2X2BT

The **STL-SL Series** Countertop Cup & Lid Dispensing Cabinets feature STL-2 cup dispensers combined with a durable and stylish polystyrene cabinet.

Unique cabinet design incorporates a high impact ABS plastic top to provide storage for lids, straws, stir-sticks and condiment packets.

Model Number	Number of STL-2 Dispensers	Cup Sizes	Cup Rim Diameter Range	Cabinet Dimensions H x W x D
STL-SL-2BT	2	8 to 44 oz.	3 1/8" – 4 1/2"	22 1/4" x 8 1/2" x 24"
STL-SL-3BT	3	8 to 44 oz.	3 1/8" – 4 1/2"	29 1/4" x 8 1/2" x 24"
STL-SL-2X2BT	4	8 to 44 oz.	3 1/8" – 4 1/2"	22 1/4" x 16 1/2" x 24"

▽ ONE-SIZE-FITS-ALL CUP DISPENSING CABINETS

**STL
SERIES**

The **STL-C Series** Countertop Combination Dispensing Cabinets feature STL-2 cup dispensers and include built-in storage for lids and straws.

These dispensing cabinets are constructed from a durable black polystyrene material.

Cabinets dispense a variety of 8 oz. to 44 oz. paper, plastic or foam cups with rim diameters ranging in size from 3 $\frac{1}{8}$ " – 4 $\frac{1}{2}$ ". Straw compartment accommodates standard and jumbo length straws.

Model Number	Location of STL-2 Dispensers	Cup Sizes	Cup Rim Diameter Range	Cabinet Dimensions H x W x D
STL-C-3RBT	Right	8 to 44 oz.	3 $\frac{1}{8}$ " – 4 $\frac{1}{2}$ "	24 $\frac{1}{4}$ " x 13" x 23"
STL-C-3LBT	Left	8 to 44 oz.	3 $\frac{1}{8}$ " – 4 $\frac{1}{2}$ "	24 $\frac{1}{4}$ " x 13" x 23"
STL-C-4RBT	Right	8 to 44 oz.	3 $\frac{1}{8}$ " – 4 $\frac{1}{2}$ "	32 $\frac{1}{4}$ " x 13" x 23"
STL-C-4LBT	Left	8 to 44 oz.	3 $\frac{1}{8}$ " – 4 $\frac{1}{2}$ "	32 $\frac{1}{4}$ " x 13" x 23"



STL-C-3RBT



STL-C-3LBT



STL-C-4RBT



STL-C-4LBT

Key Features ▽

- ONE-SIZE-FITS-ALL
- 8 oz. to 44 oz. Cup Sizes
- Angled Lid Compartments
- High Capacity Straw Organizer
- Simple and Fast Adjustment
- Paper, Plastic or Foam Cups
- No-Jam Design
- NSF Listed Cup Dispensers

Cup Sizing Chart ▽

The STL Series accommodate a variety of cup sizes ranging from 8 oz. to 44 oz. Always verify cup rim diameter prior to ordering.

SIZE-RITE

MODEL	APPROX CUP SIZE
STL-C-3RBT	8 oz. to 44 oz.
STL-C-3LBT	8 oz. to 44 oz.
STL-C-4RBT	8 oz. to 44 oz.
STL-C-4LBT	8 oz. to 44 oz.

Included Cup Dispensers ▽

The **DISPENSE-RITE** STL-2 cup dispenser is included with these cabinet models.



See pages 06–07 for additional details.

BLACK POLYSTYRENE CONSTRUCTION

SELF ADJUSTING DISPENSING FLEXIBILITY

SLR SERIES IN-COUNTER INTERCHANGEABLE BAFFLE CUP DISPENSERS

DISPENSE-RITE SLR Series cup dispensers feature quality ABS plastic construction combined with an interchangeable silicone baffle gasket system to accommodate a full range of cup sizes from 4 oz. to 44 oz.

A calibrated compression spring ensures one at a time dispensing in horizontal, angled or vertical mounting positions. The integrated mounting collar fully supports the dispenser in horizontal, angled or vertical mounting positions; no additional support is necessary. All models are NSF listed.

DISPENSE-RITE
interchangeable baffle
gasket system



The **SLR-1** is a **Slim-Line** model that is ideal for smaller cup sizes and tight spaces. The SLR-1 accepts 4 oz. to 24 oz. paper, plastic or foam cups with rim diameters from 2½"–3⅞". The SLR-1 model requires a 4½" hole cut-out and is great for many retrofit applications as it combines dispensing flexibility with space savings.



The **SLR-2** is a **One-Size-Fits-All** model that offers maximum dispensing flexibility. This dispenser is designed to accommodate a variety of 8 oz. to 44 oz. paper, plastic or foam cups with rim diameters ranging in size from 3"–4½". This model comes in three under counter lengths: 22", 17" and 28". The SLR-2 models require a 5¼" hole.



Model Number	Cup Rim Diameter Range	Under Counter Length	Ring Bezel Diameter	Mounting Hole Cut-Out
SLR-1	2½"–3⅞"	22"	6⅞"	4½"
SLR-1S	2½"–3⅞"	17"	6⅞"	4½"
SLR-2	3"–4½"	22"	7⅞"	5¼"
SLR-2S	3"–4½"	17"	7⅞"	5¼"
SLR-2L	3"–4½"	28"	7⅞"	5¼"

ABS PLASTIC CONSTRUCTION

▽ IN-COUNTER INTERCHANGEABLE BAFFLE CUP DISPENSERS

SLR-1 AND SLR-1S SLIM-LINE
IN-COUNTER INTERCHANGEABLE BAFFLE CUP DISPENSERS

The SLR-1 accepts a variety of 4 oz. to 24 oz. paper, plastic or foam cups with rim diameters from 2½"–3⅞". This model requires a 4½" hole cut-out and is great for many retrofit applications as it combines dispensing flexibility with space savings.



Spring Configurations ▽

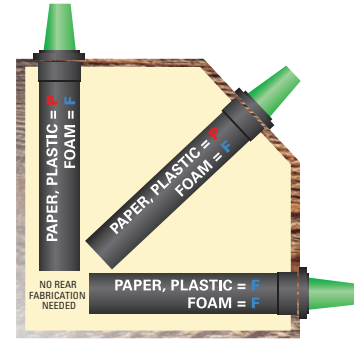

Cup Type	Position	Spring
Foam Cups	: Any Position	: F Spring
Paper Cups	: Horizontal	: F Spring
Plastic Cups	: Horizontal	: F Spring
Paper Cups	: Angled	: P Spring
Plastic Cups	: Angled	: P Spring
Paper Cups	: Vertical	: P Spring
Plastic Cups	: Vertical	: P Spring

Dispensers ship with both the "F" and "P" compression springs.

Single spring models are available; see price list for additional information.

Color Ring Bezels ▽

Optional colored ring bezels are available for SLR-2 Series cup dispensers in this popular color:



- SILVER SATIN
(stainless faux finish)

Under Counter Bracket ▽

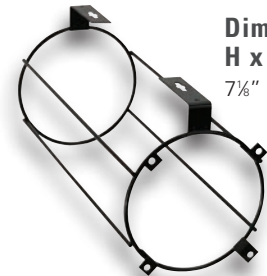

Dimensions
H x W x D
7½" x 6" x 15¼"

The optional **STL-2-SMB** wire surface mount bracket mounts to any flat surface or wire shelf and allows you to mount a SLR-2 cup dispenser in horizontal, vertical or angled positions. Maximum counter lip is 1/2".

SLR-2, SLR-2S AND SLR-2L ONE-SIZE-FITS-ALL
IN-COUNTER INTERCHANGEABLE BAFFLE CUP DISPENSERS

These dispensers accommodate a variety of 8 oz. to 44 oz. paper, plastic or foam cups with rim diameters ranging in size from 3"–4½". The SLR-2 models require a 5¼" hole.

With three under counter lengths to choose from the SLR-2 cup dispenser can be ordered to suit your particular installation requirements.

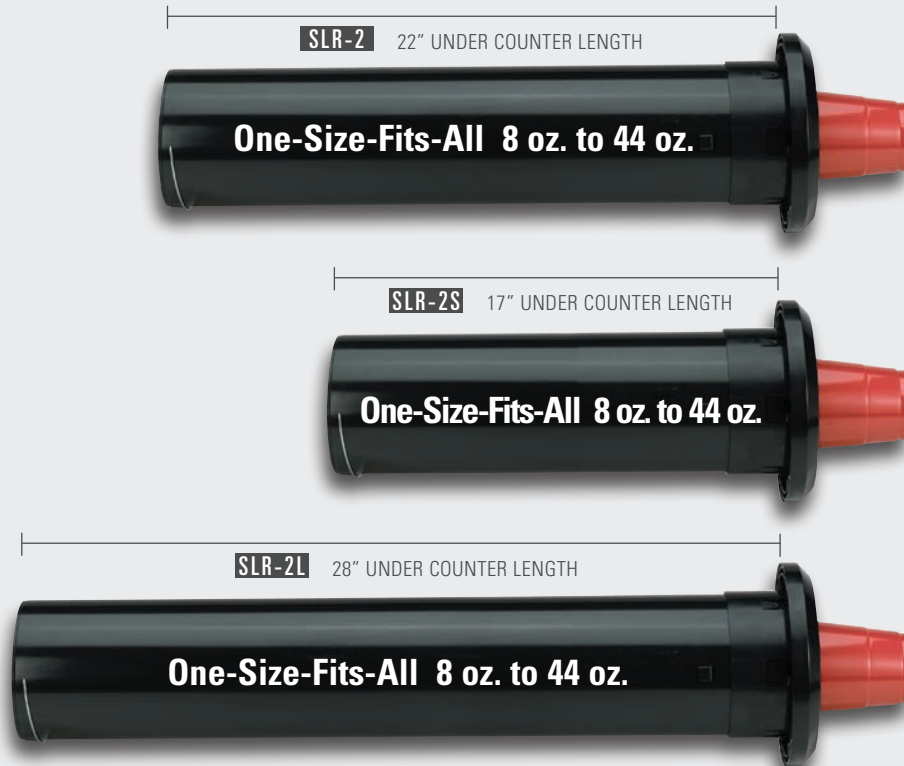

ABS PLASTIC CONSTRUCTION

▽ ONE-SIZE-FITS-ALL CUP DISPENSING CABINETS

BLACK POLYSTYRENE CONSTRUCTION



SLR-S-2BT



SLR-S-3BT



SLR-S-4BT

The **SLR-S Series** Countertop Cup Dispensing Cabinets feature SLR-2 cup dispensers combined with a durable and stylish polystyrene cabinet.

Cabinets dispense a variety of 8 oz. to 44 oz. paper, plastic or foam cups with rim diameters ranging in size from 3" – 4½".

Model Number	Number of SLR-2 Dispensers	Cup Sizes	Cup Rim Diameter Range	Cabinet Dimensions H x W x D
SLR-S-2BT	2	8 to 44 oz.	3" – 4½"	16¼" x 8" x 23"
SLR-S-3BT	3	8 to 44 oz.	3" – 4½"	24¼" x 8" x 23"
SLR-S-4BT	4	8 to 44 oz.	3" – 4½"	32¼" x 8" x 23"



SLR-SL-2BT



SLR-SL-3BT



SLR-SL-2X2BT

The **SLR-SL Series** Countertop Cup & Lid Dispensing Cabinets feature SLR-2 cup dispensers combined with a durable and stylish polystyrene cabinet.

Unique cabinet design incorporates a high impact ABS plastic top to provide storage for lids, straws, stir-sticks and condiment packets.

Model Number	Number of SLR-2 Dispensers	Cup Sizes	Cup Rim Diameter Range	Cabinet Dimensions H x W x D
SLR-SL-2BT	2	8 to 44 oz.	3" – 4½"	22¼" x 8½" x 24"
SLR-SL-3BT	3	8 to 44 oz.	3" – 4½"	29¼" x 8½" x 24"
SLR-SL-2X2BT	4	8 to 44 oz.	3" – 4½"	22¼" x 16½" x 24"

▽ ONE-SIZE-FITS-ALL CUP DISPENSING CABINETS

SLR
SERIES

The **SLR-C Series** Countertop Combination Dispensing Cabinets feature SLR-2 cup dispensers and include built-in storage for lids and straws.

These dispensing cabinets are constructed from a durable black polystyrene material.

Cabinets dispense a variety of 8 oz. to 44 oz. paper, plastic or foam cups with rim diameters ranging in size from 3" – 4½". Straw compartment accommodates standard and jumbo length straws.

Model Number	Location of SLR-2 Dispensers	Cup Sizes	Cup Rim Diameter Range	Cabinet Dimensions H x W x D
SLR-C-3RBT	Right	8 to 44 oz.	3" – 4½"	24¼" x 13" x 23"
SLR-C-3LBT	Left	8 to 44 oz.	3" – 4½"	24¼" x 13" x 23"
SLR-C-4RBT	Right	8 to 44 oz.	3" – 4½"	32¼" x 13" x 23"
SLR-C-4LBT	Left	8 to 44 oz.	3" – 4½"	32¼" x 13" x 23"



SLR-C-3RBT



SLR-C-3LBT



SLR-C-4RBT



SLR-C-4LBT

Key Features ▽

- ONE-SIZE-FITS-ALL
- 8 oz. to 44 oz. Cup Sizes
- Angled Lid Compartments
- High Capacity Straw Organizer
- Simple and Fast Adjustment
- Paper, Plastic or Foam Cups
- No-Jam Design
- NSF Listed Cup Dispensers

Cup Sizing Chart ▽

The SLR Series accommodate a variety of cup sizes ranging from 8 oz. to 44 oz. Always verify cup rim diameter prior to ordering.

SIZE-RITE

MODEL	APPROX CUP SIZE
SLR-C-3RBT	8 oz. to 44 oz.
SLR-C-3LBT	8 oz. to 44 oz.
SLR-C-4RBT	8 oz. to 44 oz.
SLR-C-4LBT	8 oz. to 44 oz.

Included Cup Dispensers ▽

The **DISPENSE-RITE** SLR-2 cup dispenser is included with these cabinet models.



See pages 12–13 for additional details.

BLACK POLYSTYRENE CONSTRUCTION

STAINLESS STEEL CONSTRUCTION



SLR-R-3SS



SLR-R-4SS

The **SLR-R Series** Countertop Cup Dispensing Cabinets feature SLR-2 cup dispensers combined with a quality stainless steel cabinet.

Cabinets dispense a variety of 8 oz. to 44 oz. paper, plastic or foam cups with rim diameters ranging in size from 3" – 4½".

Reinforced welded stainless steel cabinet construction provides long term durability.

Model Number	Number of SLR-2 Dispensers	Cup Sizes	Cup Rim Diameter Range	Cabinet Dimensions H x W x D
SLR-R-3SS	3	8 to 44 oz.	3" – 4½"	24½" x 8½" x 23"
SLR-R-4SS	4	8 to 44 oz.	3" – 4½"	32½" x 8½" x 23"

▽ ONE-SIZE-FITS-ALL CUP DISPENSING CABINETS

The **SLR-C Series** Countertop Combination Dispensing Cabinets feature SLR-2 cup dispensers and include built-in storage for lids and straws.

Cabinets dispense a variety of 8 oz. to 44 oz. paper, plastic or foam cups with rim diameters ranging in size from 3" – 4½". Straw compartment accommodates standard and jumbo length straws.

Reinforced welded stainless steel cabinet construction provides long term durability.

Model Number	Location of SLR-2 Dispensers	Cup Sizes	Cup Rim Diameter Range	Cabinet Dimensions H x W x D
SLR-C-4RSS	Right	8 to 44 oz.	3" – 4½"	32½" x 13" x 23"
SLR-C-4LSS	Left	8 to 44 oz.	3" – 4½"	32½" x 13" x 23"



SLR-C-4RSS

SLR-C-4LSS

Key Features ▾

- ONE-SIZE-FITS-ALL
- 8 oz. to 44 oz. Cup Sizes
- Angled Lid Compartments
- High Capacity Straw Organizer
- Interchangeable Baffle System
- Paper, Plastic or Foam Cups
- No-Jam Design
- NSF Listed Cup Dispensers

Cup Sizing Chart ▾

The SLR Series accommodate a variety of cup sizes ranging from 8 oz. to 44 oz. Always verify cup rim diameter prior to ordering.

SIZE-RITE

MODEL	APPROX CUP SIZE
SLR-R-3SS	8 oz. to 44 oz.
SLR-R-4SS	8 oz. to 44 oz.
SLR-C-4RSS	8 oz. to 44 oz.
SLR-C-4LSS	8 oz. to 44 oz.

Included Cup Dispensers ▾

The **DISPENSE-RITE** SLR-2 cup dispenser with matching silver satin ring bezel is included with these cabinet models.



See pages 12–13 for additional details.

STAINLESS STEEL CONSTRUCTION

MOBILE CUP DISPENSING FLEXIBILITY

MCDC SERIES MOBILE ONE-SIZE-FITS-ALL CUP DISPENSING CARTS

The **MCDC Series** Mobile Cup Dispensing Carts feature 28" long high capacity SLR-2L ABS plastic cup dispensers combined with a quality stainless steel cabinet.

Cabinets dispense a variety of 8 oz. to 44 oz. paper, plastic or foam cups as well as plastic tumblers with rim diameters ranging in size from 3" – 4½".

STAINLESS STEEL CONSTRUCTION

Welded stainless steel cabinet for long term durability

Removable bumper guards protect the cart from damage when relocating

Locking swivel casters provide the MCDC Series carts complete mobility



All MCDC Series mobile carts include removable bumper guards. Reinforced welded stainless steel cabinet construction provides long term durability. Cabinets feature built-in recessed handles and include preinstalled locking swivel casters for easy mobility.

Configurations are available with four or eight SLR-2L cup dispensers. These dispensers are intended for use with 8 oz. to 44 oz. cups and containers ranging in size from 3" to 4½".

▽ ONE-SIZE-FITS-ALL MOBILE CUP DISPENSING CARTS

**MCDC
SERIES**

Key Features ▽

- ONE-SIZE-FITS-ALL
- 8 oz. to 44 oz. Cup Sizes
- Interchangeable Baffle System
- Paper, Plastic or Foam Cups
- Plastic Tumblers
- Locking Swivel Casters
- Removable Bumper Guards
- Built-in Recessed Handles
- 28" L High Capacity Dispensers
- NSF Listed Cup Dispensers

Compatible with Tumblers

MCDC Mobile Cup Dispensing Carts can also be used with reusable plastic tumblers as shown below.



MCDC-SLR2X2

Model Number	Number of SLR-2 Dispensers	Cup Sizes	Cup Rim Diameter Range	Cabinet Dimensions H x W x D
MCDC-SLR4X1	4	8 to 44 oz.	3"-4½"	35" x 12" x 33"
MCDC-SLR4X2	8	8 to 44 oz.	3"-4½"	35" x 17½" x 33"
MCDC-SLR2X2	4	8 to 44 oz.	3"-4½"	35" x 17" x 17"



MCDC-SLR4X1

MCDC-SLR4X2

MCDC Series carts are ideal for:

- Stadiums**
- Universities**
- Concert Venues**
- Amusement Parks**
- Hospitals**
- Quick Service Restaurants**

Included Cup Dispensers ▽

The **DISPENSE-RITE** SLR-2L cup dispenser is included with these cabinet models.



See pages 12-13 for additional details.

STAINLESS STEEL CONSTRUCTION

PRECISION ADJUSTMENT DISPENSING FLEXIBILITY

DISPENSE-RITE
exclusive spring-clip
precision adjustment
mechanism

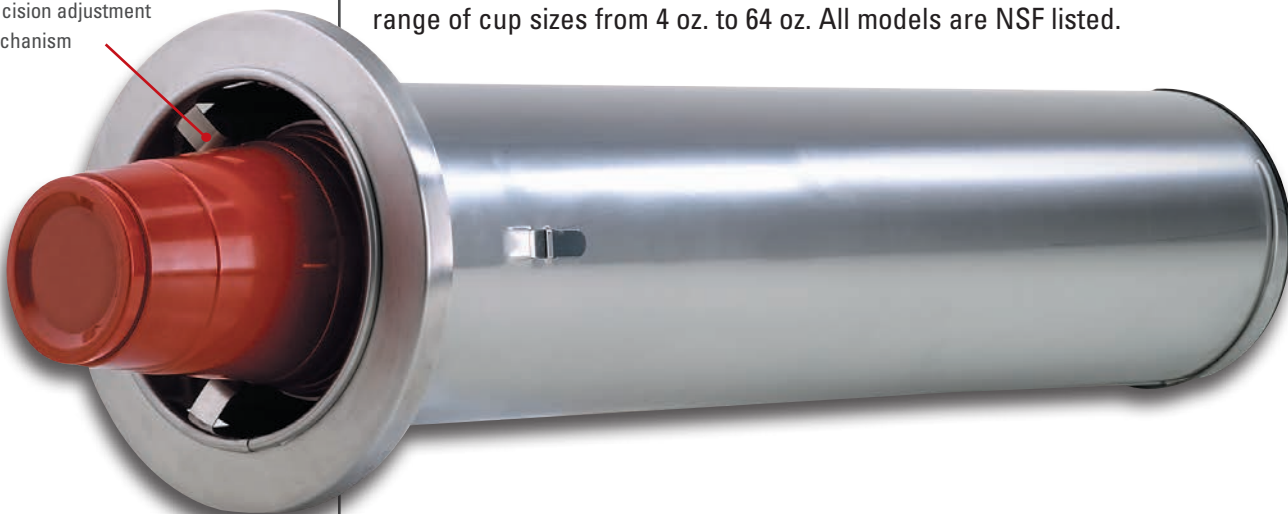

ADJ SERIES IN-COUNTER ADJUSTABLE CUP DISPENSERS

DISPENSE-RITE ADJ Series cup dispensers feature quality stainless steel construction with a quick release mounting collar. These dispensers utilize an exclusive spring-clip precision adjustment mechanism to accommodate a full range of cup sizes from 4 oz. to 64 oz. All models are NSF listed.

The **ADJ-1** and **ADJ-1.50** are **Slim-Line** models for small cup sizes and tight spaces. The ADJ-1 is designed to accommodate 4 oz. to 12 oz. paper, plastic or foam cups with rim diameters ranging in size from 2½"–3½". The ADJ-1 model requires a small 4" hole cut-out and is ideal for many retrofit applications. The ADJ-1.50 is designed to accommodate 8 oz. to 24 oz. paper, plastic or foam cups with rim diameters ranging in size from 3"–3¾". The ADJ-1.50 model requires a 4½" hole cut-out.

The **ADJ-2** is our most popular cup dispenser. This is a **One-Size-Fits-All** model that offers maximum dispensing flexibility. This unit is designed to accommodate a variety of 8 oz. to 44 oz. paper, plastic or foam cups with rim diameters ranging in size from 3"–4⅝". This model comes in two under counter lengths: 22" or 19". The ADJ-2 models require a 5¼" hole cut-out.

The **ADJ-3** is the ideal dispenser for **Jumbo-Size** drink cups and deli containers. This dispenser is designed to accommodate 44 oz. to 64 oz. paper, plastic or foam cups with rim diameters ranging in size from 4½"–5¼". The ADJ-3 model requires a larger 5¾" hole cut-out.

NSF

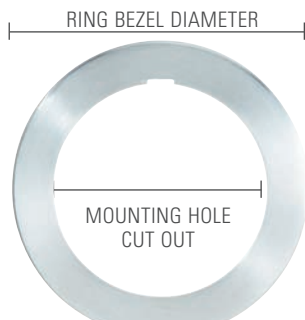

Model Number	Cup Rim Diameter Range	Under Counter Length	Ring Bezel Diameter	Mounting Hole Cut-Out
ADJ-1	2½"–3½"	22"	5⅝"	4"
ADJ-1.50	3"–3¾"	22"	5⅝"	4½"
ADJ-2	3"–4⅝"	22"	6⅞"	5¼"
ADJ-2S	3"–4⅝"	19"	6⅞"	5¼"
ADJ-3	4½"–5¼"	22"	7⅞"	5¾"

STAINLESS STEEL CONSTRUCTION

▽ **IN-COUNTER ADJUSTABLE CUP DISPENSERS**

ADJ-1 AND ADJ-1.50 SLIM-LINE CUP DISPENSERS

The ADJ-1 is designed to accommodate 4 oz. to 12 oz. paper, plastic or foam cups with rim diameters ranging in size from 2½"–3½". The ADJ-1.50 is designed to accommodate 8 oz. to 24 oz. paper, plastic or foam cups with rim diameters ranging in size from 3"–3¾".



ADJ-2 AND ADJ-2S ONE-SIZE-FITS-ALL CUP DISPENSERS

These dispensers are designed to accommodate a variety of 8 oz. to 44 oz. paper, plastic or foam cups with rim diameters ranging in size from 3"–4½".

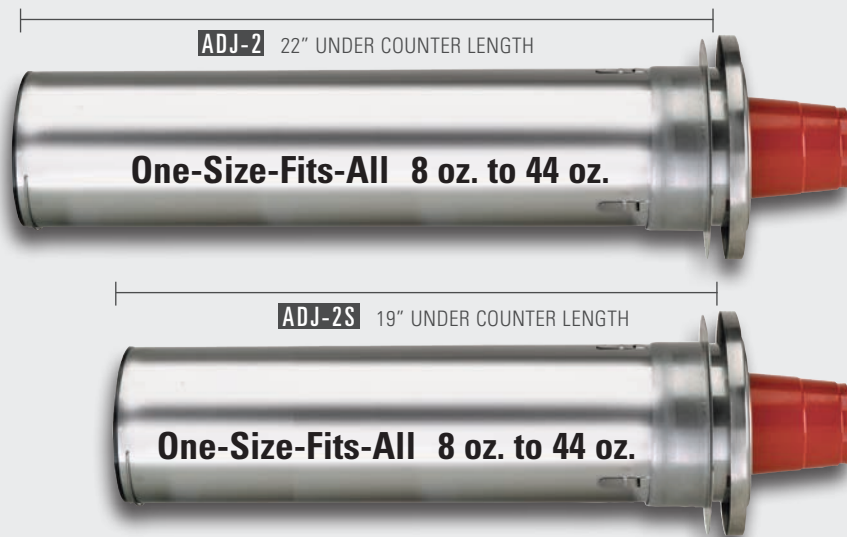

ADJ-3 JUMBO-SIZE CUP DISPENSERS

This dispenser is designed to accommodate 44 oz. to 64 oz. paper, plastic or foam cups with rim diameters ranging in size from 4½"–5¼".



Spring Configurations ▽

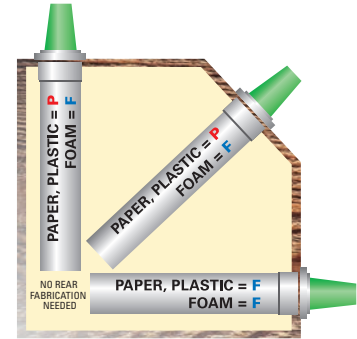

Cup Type	Position	Spring
Foam Cups	: Any Position	: F Spring
Paper Cups	: Horizontal	: F Spring
Plastic Cups	: Horizontal	: F Spring
Paper Cups	: Angled	: P Spring
Plastic Cups	: Angled	: P Spring
Paper Cups	: Vertical	: P Spring
Plastic Cups	: Vertical	: P Spring

Dispensers ship with both the "F" and "P" compression springs.

Single spring models are available; see price list for additional information.

Color Ring Bezels ▽

Stainless ring bezels are standard on all models. Optional gloss black powder coated ring bezels are available for ADJ-2 Series cup dispensers.

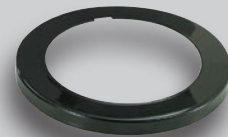

- **BUMPER BLACK** (high gloss)
Available only for the ADJ-2 and ADJ-2S models

Under Counter Bracket ▽

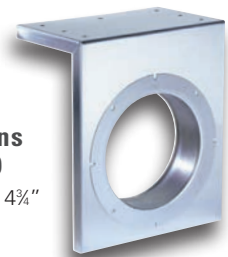

Dimensions
H x W x D
9½" x 7¾" x 4¾"

The optional **UCMB-2** stainless steel under counter bracket mounts to any flat surface or wire shelf creating a face plate to mount an ADJ-2 cup dispenser. Maximum counter lip is 1½".

STAINLESS STEEL CONSTRUCTION

STAINLESS STEEL CONSTRUCTION

Included Cup Dispensers ▾

The **DISPENSE-RITE** ADJ-2 cup dispenser is included with these cabinet models.

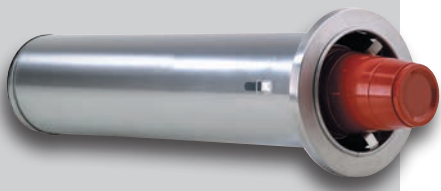

See pages 18–19 for additional details.



CTC-R-2SS

CTC-R-3SS

CTC-R-4SS

The **CTC-R Series** Countertop Cup Dispensing Cabinets feature ADJ-2 stainless steel cup dispensers combined with a quality stainless steel cabinet.

Cabinets dispense a variety of 8 oz. to 44 oz. paper, plastic or foam cups with rim diameters ranging in size from 3" – 4 5/8".

Reinforced welded stainless steel cabinet construction provides long term durability. Quick-release mounting brackets allow simple and fast dispenser removal for cleaning or adjustment.

Model Number	Number of ADJ-2 Dispensers	Cup Sizes	Cup Rim Diameter Range	Cabinet Dimensions H x W x D
CTC-R-2SS	2	8 to 44 oz.	3"–4 5/8"	16 1/2" x 8 1/8" x 23"
CTC-R-3SS	3	8 to 44 oz.	3"–4 5/8"	24 1/2" x 8 1/8" x 23"
CTC-R-4SS	4	8 to 44 oz.	3"–4 5/8"	32 1/2" x 8 1/8" x 23"

▽ ONE-SIZE-FITS-ALL CUP DISPENSING CABINETS

Key Features ▽

- ONE-SIZE-FITS-ALL
- 8 oz. to 44 oz. Cup Sizes
- Precision Adjustment
- Lid & Straw Organizer
- Paper, Plastic or Foam Cups
- Quick-Release Brackets
- NSF Listed Cup Dispensers

Color Ring Bezels ▽

Stainless ring bezels are standard on all models. Optional gloss black powder coated ring bezels are available for CTC Series cup dispensing cabinets.

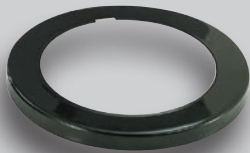

- BUMPER BLACK (high gloss)

Model Number	Number of ADJ-2 Dispensers	Cup Sizes	Cup Rim Diameter Range	Cabinet Dimensions H x W x D
CTC-L-2SS	2	8 to 44 oz.	3"–4½"	22¾" x 8¾" x 23½"
CTC-L-3SS	3	8 to 44 oz.	3"–4½"	29¾" x 8¾" x 23½"
CTC-L-2X2SS	4	8 to 44 oz.	3"–4½"	22½" x 16½" x 22¾"



CTC-L-2X2SS



CTC-L-2SS

CTC-L-3SS

The **CTC-L Series** Countertop Cup & Lid Dispensing Cabinets feature ADJ-2 stainless steel cup dispensers combined with a quality stainless steel cabinet.

Cabinets dispense a variety of 8 oz. to 44 oz. paper, plastic or foam cups with rim diameters ranging in size from 3" – 4½".

Unique cabinet design incorporates a removable ABS plastic top to provide storage for lids, straws, stir-sticks and condiment packets. The durable top removes quickly and easily for cleaning.

Quick-release mounting brackets allow simple and fast cup dispenser removal for cleaning or adjustment.

STAINLESS STEEL CONSTRUCTION

▽ **ONE-SIZE-FITS-ALL CUP DISPENSING CABINETS**

BLACK POLYSTYRENE CONSTRUCTION

Included Cup Dispensers ▾

The **DISPENSE-RITE** ADJ-2 cup dispenser with matching gloss black ring bezel is included with these cabinet models.



See pages 18-19 for additional details.



CTC-S-2BT

CTC-S-3BT

CTC-S-4BT

The **CTC-S Series** Countertop Cup Dispensing Cabinets feature ADJ-2 stainless steel cup dispensers combined with a durable and stylish polystyrene cabinet.

Cabinets dispense a variety of 8 oz. to 44 oz. paper, plastic or foam cups with rim diameters ranging in size from 3" – 4 5/8".

Dispensers feature matching gloss black ring bezels and a quick-release mounting bracket.

Model Number	Number of ADJ-2 Dispensers	Cup Sizes	Cup Rim Diameter Range	Cabinet Dimensions H x W x D
CTC-S-2BT	2	8 to 44 oz.	3"–4 5/8"	16 1/4" x 8" x 23"
CTC-S-3BT	3	8 to 44 oz.	3"–4 5/8"	24 1/4" x 8" x 23"
CTC-S-4BT	4	8 to 44 oz.	3"–4 5/8"	32 1/4" x 8" x 23"

▽ ONE-SIZE-FITS-ALL CUP DISPENSING CABINETS

**CTC
SERIES**

The **CTC-C Series** and **CTC-M Series** Countertop Combination Cup Dispensing Cabinets feature ADJ-2 stainless steel cup dispensers and include built-in storage for lids and straws.

Cabinets dispense a variety of 8 oz. to 44 oz. paper, plastic or foam cups with rim diameters ranging in size from 3" – 4 $\frac{5}{8}$ ". Straw compartment accommodates standard and jumbo length straws.

Dispensers feature matching high gloss black ring bezels and a quick-release mounting bracket.

Model Number	Number of ADJ-2 Dispensers	Cup Sizes	Cup Rim Diameter Range	Cabinet Dimensions H x W x D
CTC-C-2BT	2	8 to 44 oz.	3"–4 $\frac{5}{8}$ "	16 $\frac{1}{4}$ " x 13" x 23"
CTC-C-3BT	3	8 to 44 oz.	3"–4 $\frac{5}{8}$ "	24 $\frac{1}{4}$ " x 13" x 23"
CTC-C-4BT	4	8 to 44 oz.	3"–4 $\frac{5}{8}$ "	32 $\frac{1}{4}$ " x 13" x 23"
CTC-M-3BT	3	8 to 44 oz.	3"–4 $\frac{5}{8}$ "	32 $\frac{1}{4}$ " x 11" x 23"



BLACK POLYSTYRENE CONSTRUCTION

Key Features ▽

- ONE-SIZE-FITS-ALL
- 8 oz. to 44 oz. Cup Sizes
- Precision Adjustment Mechanism
- Angled Lid Compartments
- High Capacity Straw Organizer
- Paper, Plastic or Foam Cups
- Quick-Release Mounting Brackets
- NSF Listed Cup Dispensers

Cup Sizing Chart ▽

SIZE-RITE	
MODEL	APPROX CUP SIZE
CTC-S-2BT	8 oz. to 44 oz.
CTC-S-3BT	8 oz. to 44 oz.
CTC-S-4BT	8 oz. to 44 oz.
CTC-C-2BT	8 oz. to 44 oz.
CTC-C-3BT	8 oz. to 44 oz.
CTC-C-4BT	8 oz. to 44 oz.
CTC-M-3BT	8 oz. to 44 oz.



INNOVATIVE COMBINATION DISPENSING

CTC-C SERIES COUNTERTOP ADJUSTABLE **ONE-SIZE-FITS-ALL** CUP DISPENSING CABINETS WITH BUILT-IN LID & STRAW ORGANIZERS

The innovative **CTC-C Series** combination dispensing cabinets feature ADJ-2 One-Size-Fits-All cup dispensers and include built-in storage for lids and straws.

Cabinets dispense a variety of 8 oz. to 44 oz. paper, plastic or foam cups with rim diameters ranging in size from 3" – 4 $\frac{5}{8}$ ".

Reinforced welded stainless steel cabinet construction provides long term durability. Quick-release mounting brackets allow simple and fast dispenser removal for cleaning or adjustment.



Cabinets can be ordered with the cup dispensers on either the right or left side. Combination Cup, Lid and Straw Dispensing Cabinets offer maximum dispensing flexibility and provide convenient access to drink accessory items.

DISPENSE-RITE quality stainless steel cabinets are designed to provide long lasting trouble-free cup dispensing.

STAINLESS STEEL CONSTRUCTION

▽ ONE-SIZE-FITS-ALL CUP DISPENSING CABINETS

**CTC
SERIES**

Model Number	Number of ADJ-2 Dispensers	Cup Sizes	Cup Rim Diameter Range	Cabinet Dimensions H x W x D
CTC-C-3RSS	3	8 to 44 oz.	3"-4 1/4"	25 3/8" x 13" x 23"
CTC-C-3LSS	3	8 to 44 oz.	3"-4 1/4"	25 3/8" x 13" x 23"
CTC-C-4RSS	4	8 to 44 oz.	3"-4 1/4"	32 1/2" x 13" x 23"
CTC-C-4LSS	4	8 to 44 oz.	3"-4 1/4"	32 1/2" x 13" x 23"

Key Features ▽

- ONE-SIZE-FITS-ALL
- 8 oz. to 44 oz. Cup Sizes
- Precision Adjustment
- Angled Lid Compartments
- High Capacity Straw Organizer
- Paper, Plastic or Foam Cups
- Quick-Release Brackets
- NSF Listed Cup Dispensers

Cup Sizing Chart ▽

The CTC-C Series accommodates a variety of cup sizes ranging from 8 oz. to 44 oz. Always verify cup rim diameter prior to ordering.

SIZE-RITE

MODEL	APPROX CUP SIZE
CTC-C-3RSS	8 oz. to 44 oz.
CTC-C-3LSS	8 oz. to 44 oz.
CTC-C-4RSS	8 oz. to 44 oz.
CTC-C-4LSS	8 oz. to 44 oz.

Color Ring Bezels ▽

Stainless ring bezels are standard on all models. Optional gloss black powder coated ring bezels are available for CTC Series cup dispensing cabinets.



- BUMPER BLACK (high gloss)

Included Cup Dispensers ▽

The **DISPENSE-RITE** ADJ-2 cup dispenser is included with these cabinet models.

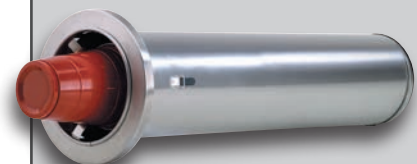

See pages 18-19 for additional details.



CTC-C-3RSS



CTC-C-3LSS



CTC-C-4RSS



CTC-C-4LSS

STAINLESS STEEL CONSTRUCTION

SELF-ADJUSTING DISPENSING FLEXIBILITY

BFL SERIES IN-COUNTER INTERCHANGEABLE BAFFLE CUP DISPENSERS

DISPENSE-RITE BFL Series cup dispensers feature quality stainless steel construction. These dispensers utilize an interchangeable silicone baffle gasket system to accommodate a full range of cup sizes from 8 oz. to 64 oz.

A calibrated compression spring ensures one at a time dispensing in horizontal, angled or vertical mounting positions. The quick-release mounting bracket fully supports the dispenser in horizontal, angled or vertical mounting positions and no additional support is necessary. All models are NSF listed.

DISPENSE-RITE
interchangeable baffle
gasket system



STAINLESS STEEL CONSTRUCTION

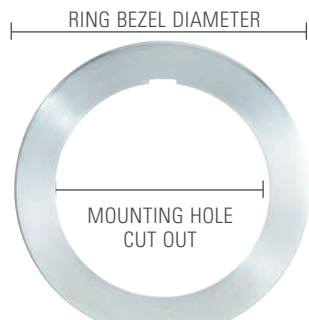

The **BFL-2** is a **One-Size-Fits-All** model that offers maximum dispensing flexibility. This unit is designed to accommodate a variety of 8 oz. to 44 oz. paper, plastic or foam cups with rim diameters ranging in size from 3"–4½". This model comes in two under counter lengths: 22" or 19". The BFL-2 models require a 5¼" hole cut-out.

The **BFL-3** is the ideal dispenser for **Jumbo-Size** drink cups and deli containers. This unit is designed to accommodate a variety of 44 oz. to 64 oz. paper, plastic or foam cups with rim diameters ranging in size from 4½"–5¼". The BFL-3 model requires a larger 5¾" hole cut-out.

Model Number	Cup Rim Diameter Range	Under Counter Length	Ring Bezel Diameter	Mounting Hole Cut-Out
BFL-2	3"–4½"	22"	6⅝"	5¼"
BFL-2S	3"–4½"	19"	6⅝"	5¼"
BFL-3	4½"–5¼"	22"	7⅝"	5¾"

▽ **IN-COUNTER INTERCHANGEABLE BAFFLE CUP DISPENSERS**

**BFL-2, BFL-2S ONE-SIZE-FITS-ALL
IN-COUNTER INTERCHANGEABLE BAFFLE CUP DISPENSERS**

These dispensers are designed to accommodate a variety of 8 oz. to 44 oz. paper, plastic or foam cups with rim diameters ranging in size from 3"–4½".

With two under counter lengths to choose from the BFL-2 cup dispenser can be ordered to suit your particular installation requirements.

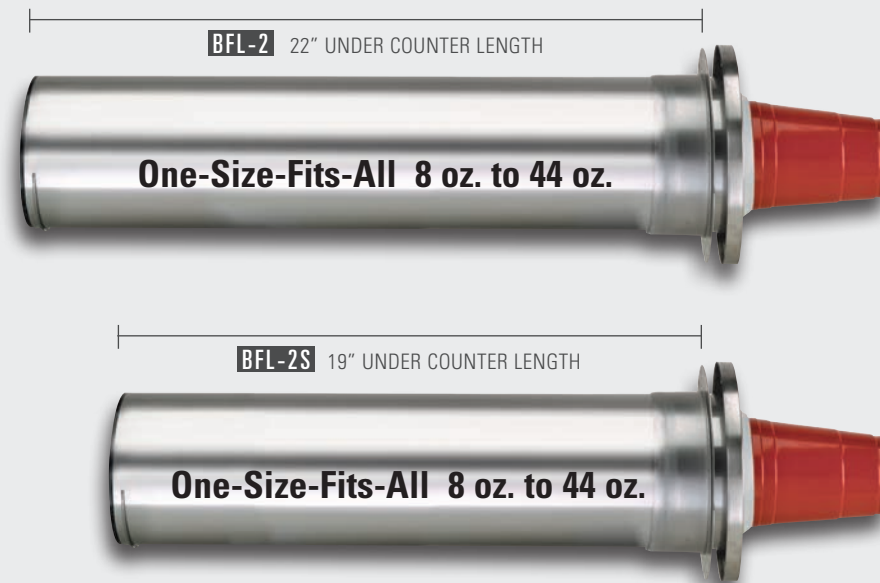

**BFL-3 JUMBO-SIZE
IN-COUNTER INTERCHANGEABLE BAFFLE CUP DISPENSERS**

This dispenser is designed to accommodate 44 oz. to 64 oz. paper, plastic or foam cups with rim diameters ranging in size from 4½"–5¼".



- Above models include multiple silicone baffles and are for use with the cup rim diameter range listed. Ounce capacities are provided for reference only. Always verify cup rim diameter prior to ordering.
- Above models ship with 2 different compression springs "F" & "P". See spring configuration chart in upper right for more details.

Spring Configurations ▾

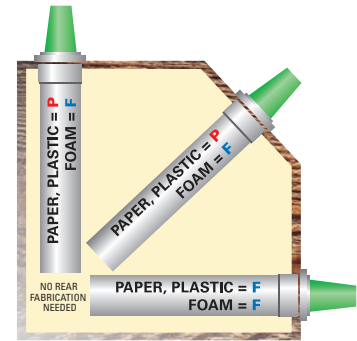

Cup Type	Position	Spring
Foam Cups	: Any Position	: F Spring
Paper Cups	: Horizontal	: F Spring
Plastic Cups	: Horizontal	: F Spring
Paper Cups	: Angled	: P Spring
Plastic Cups	: Angled	: P Spring
Paper Cups	: Vertical	: P Spring
Plastic Cups	: Vertical	: P Spring

Dispensers ship with both the "F" and "P" compression springs.

Single spring models are available; see price list for additional information.

Color Ring Bezels ▾

Stainless ring bezels are standard on all models. Optional gloss black powder coated ring bezels are available for BFL-2 Series cup dispensers.

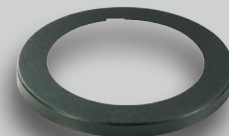

- **BLACK RIDGE**
(matte textured)

Available only for the BFL-2 and BFL-2S models

Under Counter Bracket ▾

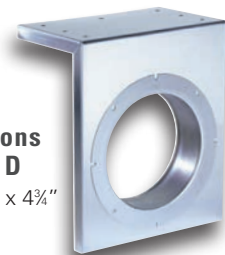

Dimensions
H x W x D
9½" x 7¾" x 4¾"

The optional **UCMB-2** stainless steel under counter bracket mounts to any flat surface or wire shelf creating a face plate to mount a BFL-2 cup dispenser. Maximum counter lip is 1½".

STAINLESS STEEL CONSTRUCTION

Included Cup Dispensers ▽

The **DISPENSE-RITE** BFL-2 cup dispenser is included with these cabinet models.



See pages 26–27 for additional details.



BFL-R-2SS



BFL-R-3SS



BFL-R-4SS

The **BFL-R Series** Countertop Cup Dispensing Cabinets feature BFL-2 stainless steel cup dispensers combined with a quality stainless steel cabinet.

Cabinets dispense a variety of 8 oz. to 44 oz. paper, plastic or foam cups with rim diameters ranging in size from 3" – 4½".

Reinforced welded stainless steel cabinet construction provides long term durability. Quick-release mounting brackets allow simple and fast dispenser removal for cleaning or adjustment.

Model Number	Number of BFL-2 Dispensers	Cup Sizes	Cup Rim Diameter Range	Cabinet Dimensions H x W x D
BFL-R-2SS	2	8 to 44 oz.	3"–4½"	16½" x 8½" x 23"
BFL-R-3SS	3	8 to 44 oz.	3"–4½"	24½" x 8½" x 23"
BFL-R-4SS	4	8 to 44 oz.	3"–4½"	32½" x 8½" x 23"

▽ ONE-SIZE-FITS-ALL CUP DISPENSING CABINETS

Key Features ▽

- ONE-SIZE-FITS-ALL
- 8 oz. to 44 oz. Cup Sizes
- Interchangeable Baffle System
- Integrated Lid, Straw and Condiment Organizer
- Paper, Plastic or Foam Cups
- Quick-Release Brackets
- NSF Listed Cup Dispensers

Color Ring Bezels ▽

Stainless ring bezels are standard. Optional powder coated ring bezels are available in this popular color:

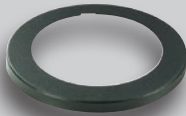

- **BLACK RIDGE**
(matte textured)

Model Number	Number of BFL-2 Dispensers	Cup Sizes	Cup Rim Diameter Range	Cabinet Dimensions H x W x D
BFL-L-2SS	2	8 to 44 oz.	3"–4½"	22¾" x 8¾" x 23½"
BFL-L-3SS	3	8 to 44 oz.	3"–4½"	29¾" x 8¾" x 23½"
BFL-L-2X2SS	4	8 to 44 oz.	3"–4½"	22½" x 16½" x 22¾"



BFL-L-2X2SS



BFL-L-2SS



BFL-L-3SS

The **BFL-L Series** Countertop Cup & Lid Dispensing Cabinets feature BFL-2 stainless steel cup dispensers combined with a quality stainless steel cabinet.

Unique cabinet design incorporates a removable ABS plastic top to provide storage for lids, straws, stir-sticks and condiment packets. This durable top removes quickly and easily for cleaning.

Reinforced welded stainless steel cabinet construction provides long term durability. Quick-release mounting brackets allow simple and fast cup dispenser removal for cleaning or adjustment.

STAINLESS STEEL CONSTRUCTION

BLACK POLYSTYRENE CONSTRUCTION

Included Cup Dispensers ▾

The **DISPENSE-RITE** BFL-2 cup dispenser with matching matte black ring bezel is included with these cabinet models.



See pages 26–27 for additional details.

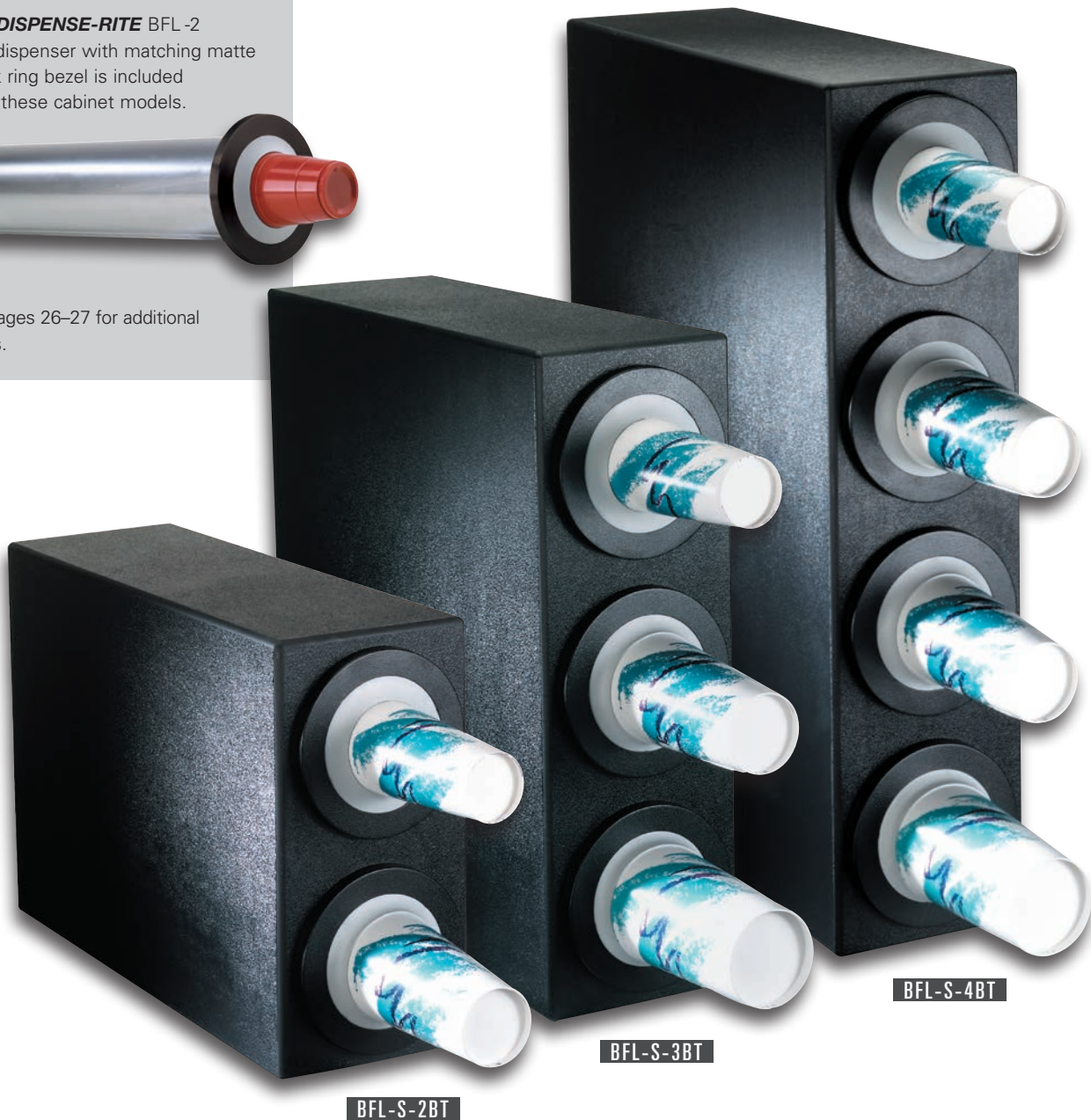

The **BFL-S Series** Countertop Cup Dispensing Cabinets feature BFL-2 stainless steel cup dispensers combined with a durable and stylish polystyrene cabinet.

Cabinets dispense a variety of 8 oz. to 44 oz. paper, plastic or foam cups with rim diameters ranging in size from 3" – 4½".

Dispensers feature matching matte black ring bezels and a quick-release mounting bracket.

Model Number	Number of BFL-2 Dispensers	Cup Sizes	Cup Rim Diameter Range	Cabinet Dimensions H x W x D
BFL-S-2BT	2	8 to 44 oz.	3"–4½"	16¼" x 8" x 23"
BFL-S-3BT	3	8 to 44 oz.	3"–4½"	24¼" x 8" x 23"
BFL-S-4BT	4	8 to 44 oz.	3"–4½"	32¼" x 8" x 23"

▽ ONE-SIZE-FITS-ALL CUP DISPENSING CABINETS

**BFL
SERIES**

The **BFL-C Series** Countertop Combination Dispensing Cabinets feature BFL-2 cup dispensers and include built-in storage for lids and straws.

Cabinets dispense a variety of 8 oz. to 44 oz. paper, plastic or foam cups with rim diameters ranging in size from 3" – 4½". Divided straw compartment accommodates standard and jumbo length straws.

Dispensers feature matching matte black ring bezels and a quick-release mounting bracket.

Model Number	Number of BFL-2 Dispensers	Cup Sizes	Cup Rim Diameter Range	Cabinet Dimensions H x W x D
BFL-C-2BT	2	8 to 44 oz.	3"–4½"	16¼" x 13" x 23"
BFL-C-3BT	3	8 to 44 oz.	3"–4½"	24¼" x 13" x 23"
BFL-C-4BT	4	8 to 44 oz.	3"–4½"	32¼" x 13" x 23"



BLACK POLYSTYRENE CONSTRUCTION

Key Features ▽

- ONE-SIZE-FITS-ALL
- 8 oz. to 44 oz. Cup Sizes
- Interchangeable Baffle System
- Angled Lid Compartments
- High Capacity Straw Organizer
- Paper, Plastic or Foam Cups
- NSF Listed Cup Dispensers

Cup Sizing Chart ▽

SIZE-RITE		SIZE-RITE	
MODEL	APPROX CUP SIZE	MODEL	APPROX CUP SIZE
BFL-S-2BT	8 oz. to 44 oz.	BFL-C-2BT	8 oz. to 44 oz.
BFL-S-3BT	8 oz. to 44 oz.	BFL-C-3BT	8 oz. to 44 oz.
BFL-S-4BT	8 oz. to 44 oz.	BFL-C-4BT	8 oz. to 44 oz.

INNOVATIVE COMBINATION DISPENSING

BFL-C SERIES COUNTERTOP INTERCHANGEABLE BAFFLE **ONE-SIZE-FITS-ALL** CUP DISPENSING CABINETS WITH BUILT-IN LID & STRAW ORGANIZERS

The innovative **BFL-C Series** combination dispensing cabinets feature BFL-2 One-Size-Fits-All cup dispensers and include built-in storage for lids and straws.

Cabinets dispense a variety of 8 oz. to 44 oz. paper, plastic or foam cups with rim diameters ranging in size from 3" – 4½".

Reinforced welded stainless steel cabinet construction provides long term durability. Quick-release mounting brackets allow simple and fast dispenser removal for cleaning or baffle replacement.



STAINLESS STEEL CONSTRUCTION

Cabinets can be ordered with the cup dispensers on either the right or left side. Combination Cup, Lid and Straw Dispensing Cabinets offer maximum dispensing flexibility and provide convenient access to drink accessory items. **DISPENSE-RITE** quality stainless steel cabinets are designed to provide long lasting trouble-free cup dispensing.

▽ ONE-SIZE-FITS-ALL CUP DISPENSING CABINETS

**BFL
SERIES**

Model Number	Number of BFL-2 Dispensers	Cup Sizes	Cup Rim Diameter Range	Cabinet Dimensions H x W x D
BFL-C-3RSS	3	8 to 44 oz.	3"-4½"	25¾" x 13" x 23"
BFL-C-3LSS	3	8 to 44 oz.	3"-4½"	25¾" x 13" x 23"
BFL-C-4RSS	4	8 to 44 oz.	3"-4½"	32½" x 13" x 23"
BFL-C-4LSS	4	8 to 44 oz.	3"-4½"	32½" x 13" x 23"

Key Features ▽

- ONE-SIZE-FITS-ALL
- 8 oz. to 44 oz. Cup Sizes
- Interchangeable Baffle System
- Angled Lid Compartments
- High Capacity Straw Organizer
- Paper, Plastic or Foam Cups
- Quick Release Brackets
- NSF Listed Cup Dispensers

Cup Sizing Chart ▽

The BFL-C Series accommodates a variety of cup sizes ranging from 8 oz. to 44 oz. Always verify cup rim diameter prior to ordering.

SIZE-RITE

MODEL	APPROX CUP SIZE
BFL-C-3RSS	8 oz. to 44 oz.
BFL-C-3LSS	8 oz. to 44 oz.
BFL-C-4RSS	8 oz. to 44 oz.
BFL-C-4LSS	8 oz. to 44 oz.

Color Ring Bezels ▽

Stainless ring bezels are standard. Optional powder coated ring bezels are available in this popular color:

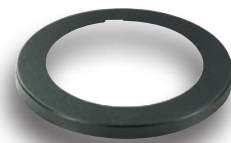

- BLACK RIDGE (matte textured)

Included Cup Dispensers ▽

The **DISPENSE-RITE** BFL-2 cup dispenser is included with these cabinet models.



See pages 26-27 for additional details.



BFL-C-3RSS



BFL-C-3LSS



BFL-C-4RSS



BFL-C-4LSS

STAINLESS STEEL CONSTRUCTION

LID DISPENSING FLEXIBILITY SIMPLIFIED

SLR-LID-2 SERIES IN-COUNTER SPRING-LOADED LID DISPENSERS

DISPENSE-RITE SLR-LID-2 Series lid dispensers are designed to combine simplicity with dependability for long-term reliability and maximum cost savings.

This sanitary beverage lid dispenser requires no adjustment and is available for a variety of in-counter and countertop applications. Lid stacks are enclosed to protect from potential contamination due to spills, splashes and sneezes. All parts are easily removable for simple cleaning. NSF Listed.

DISPENSE-RITE
lid dispenser design
requires no adjustment
and provides easy one
handed operation



SLR-LID-2

IMPORTANT INFORMATION ON LID COMPATIBILITY

DISPENSE-RITE SLR-LID-2 Series Lid Dispensers are primarily intended for use with flat, cold beverage lids. Lids that are tightly nested or have deep extrusions may not be compatible. To confirm lid compatibility please contact a DISPENSE-RITE representative and provide a full sleeve of lids for testing prior to ordering.

SLR-STRAW-2 IN-COUNTER STRAW ORGANIZER

The SLR-STRAW-2 in-counter straw organizer holds standard and jumbo length straws. These straw organizers look great with any SLR Series lid or cup dispenser. All parts are easily removable for simple cleaning. NSF Listed.

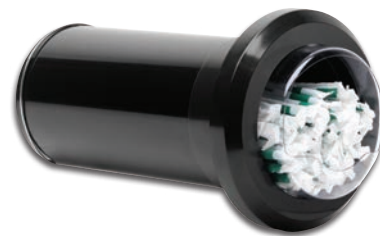

SLR-STRAW-2



Model Number	Maximum Lid Diameter	Under Counter Length	Ring Bezel Diameter	Mounting Hole Cut-Out
SLR-LID-2	4 5/8"	22"	7 1/8"	5 1/4"
SLR-LID-2S	4 5/8"	17"	7 1/8"	5 1/4"
SLR-STRAW-2	-	12"	7 1/8"	5 1/4"

ABS PLASTIC CONSTRUCTION

▽ COUNTERTOP LID, CUP & STRAW DISPENSING CABINETS



LID2-S1-2BT



LID2-S1-3BT



LID2-S2-2BT



LID2-S2-3BT

SLR-LID-2 SERIES COUNTERTOP LID, CUP & STRAW DISPENSING CABINETS

Countertop dispensing cabinets combine lid, cup and straw dispensers with a durable and stylish black polystyrene housing.

Cabinets dispense 8 oz. to 44 oz. paper, plastic or foam cups and lids with rim diameters ranging in size from 3" – 4½". Not all lids are compatible.

Model Number	Number of Dispensers	Cup / Lid Sizes	Cup / Lid Rim Diameter Range	Cabinet Dimensions H x W x D
LID2-S1-2BT	2	8 to 44 oz.	3" – 4½"	16¼" x 8" x 23"
LID2-S1-3BT	3	8 to 44 oz.	3" – 4½"	24¼" x 8" x 23"
LID2-S2-2BT	2	8 to 44 oz.	3" – 4½"	24¼" x 8" x 23"
LID2-S2-3BT	3	8 to 44 oz.	3" – 4½"	24¼" x 8" x 23"

▽ COUNTERTOP STACKABLE CUP, LID & STRAW ORGANIZERS



STK Series products can be stacked on top of each other to create a variety of custom cup, lid, straw and condiment dispensing configurations



NLO-STK-1BT



SLR-STK-1BT



LID-STK-1BT



STR-STK-1BT

STK SERIES COUNTERTOP STACKABLE CUP, LID, STRAW & CONDIMENT ORGANIZERS

Modular stackable cabinet design allows for a variety of configurations of countertop cup, lid, straw and condiment dispensers. Short cabinet depth is ideal for use in areas with limited space.

The SLR-STK-1BT includes an SLR-2S to accommodate a variety of 8 oz. to 44 oz. paper, plastic or foam cups with rim diameters ranging from 3"–4½". Not all lids are compatible with LID-STK-1BT.

Model Number	Item Description	Dimensions H x W x D
NLO-STK-1BT	Stackable Lid, Straw & Condiment Organizer	7½" x 8" x 19½"
SLR-STK-1BT	Stackable Cup Dispensing Cabinet with (1) SLR-2S	8¼" x 8" x 18½"
LID-STK-1BT	Stackable Lid Dispensing Cabinet with (1) SLR-LID-2S	8¼" x 8" x 18½"
STR-STK-1BT	Stackable Straw Dispensing Cabinet with (1) SLR-STRAW-2	8¼" x 8" x 18½"

ADJ-NW & ADJ-NS ADJUSTABLE CUP DISPENSERS

Simple and fast adjustment of five stainless steel models will accurately dispense cups with rim diameters ranging in size from 2⁵/₈"–4³/₄".

To select the correct model dispenser please measure the top rim diameter of your cup and refer to the sizing chart on the right.

ADJ-NW Series Cup Dispensers are pull-type (gravity feed) and are intended for use in vertical or angled mounting positions.

ADJ-NS Series Cup Dispensers are spring-loaded and are intended for use in horizontal or vertical mounting positions.

Dispensers are shipped with two sets of stainless steel mounting brackets and can be mounted to a wall or surface. A countertop stand is also available (see page 37).

All cup dispenser models are NSF listed.

Model Number	Cup Rim Diameter Range	Tube Diameter	Tube Length	Paper/Plastic Cup Sizes	Foam Cup Sizes
PULL -TYPE SURFACE OR STAND MOUNTED CUP DISPENSERS					
ADJ-NW-21	2 ⁵ / ₈ "–3 ³ / ₃₂ "	3 ⁵ / ₁₆ "	25 ¹ / ₂ "	6 oz. to 12 oz.	6 oz. to 8 oz.
ADJ-NW-31	2 ⁷ / ₈ "–3 ¹ / ₂ "	3 ¹¹ / ₁₆ "	25 ¹ / ₂ "	12 oz. to 22 oz.	8 oz. to 12 oz.
ADJ-NW-81	3 ¹ / ₄ "–3 ⁷ / ₈ "	4 ¹ / ₈ "	25 ¹ / ₂ "	14 oz. to 24 oz.	12 oz. to 24 oz.
ADJ-NW-101	3 ³ / ₄ "–4 ⁵ / ₁₆ "	4 ⁵ / ₈ "	25 ¹ / ₂ "	32 oz.	32 oz.
ADJ-NW-151	4 ¹ / ₈ "–4 ³ / ₄ "	4 ⁷ / ₈ "	25 ¹ / ₂ "	44 oz.	32 oz. to 44 oz.
SPRING-LOADED SURFACE OR STAND MOUNTED CUP DISPENSERS					
ADJ-NS-21	2 ⁵ / ₈ "–3 ³ / ₃₂ "	3 ⁵ / ₁₆ "	25 ¹ / ₂ "	6 oz. to 12 oz.	6 oz. to 8 oz.
ADJ-NS-31	2 ⁷ / ₈ "–3 ¹ / ₂ "	3 ¹¹ / ₁₆ "	25 ¹ / ₂ "	12 oz. to 22 oz.	8 oz. to 12 oz.
ADJ-NS-81	3 ¹ / ₄ "–3 ⁷ / ₈ "	4 ¹ / ₈ "	25 ¹ / ₂ "	14 oz. to 24 oz.	12 oz. to 24 oz.
ADJ-NS-101	3 ³ / ₄ "–4 ⁵ / ₁₆ "	4 ⁵ / ₈ "	25 ¹ / ₂ "	32 oz.	32 oz.
ADJ-NS-151	4 ¹ / ₈ "–4 ³ / ₄ "	4 ⁷ / ₈ "	25 ¹ / ₂ "	44 oz.	32 oz. to 44 oz.

STAINLESS STEEL CONSTRUCTION

PULL-TYPE DISPENSERS



SPRING-LOADED DISPENSERS



▽ SURFACE OR STAND MOUNTED LID DISPENSERS

TLD SERIES TUBULAR LID DISPENSERS

Stainless steel lid dispensers mount to a wall or surface or they can be attached to the EZ-3EZ countertop stand.

Dispensers are shipped with two sets of stainless steel mounting brackets and hardware. The brackets can be attached to the rear or side of the unit for multiple installation options.

Model Number	Max Lid Rim Diameter	Max Lid Size	Tube Diameter	Tube Length	Number of Lid Sections
SURFACE OR STAND MOUNTED TUBULAR LID DISPENSERS					
TLD-2-2	4 1/8"	6 oz. to 24 oz.	4 1/4"	25 1/2"	2
TLD-3-3	4 3/4"	12 oz. to 44 oz.	4 7/8"	25 1/2"	3



DISPENSE-RITE cup and lid dispensers include mounting brackets for attaching to walls or any flat surface.

Cup and lid dispensers can also be stand mounted to the EZ-3EZ countertop stand as shown here.



STAINLESS STEEL CONSTRUCTION

▽ COUNTERTOP STAND FOR CUP & LID DISPENSERS



EZ-3EZ

EZ-3EZ COUNTERTOP DISPENSING STAND

The EZ-3EZ countertop stand can be used with three ADJ-NW Series cup dispensers and/or TLD Series lid dispensers. When ordering please specify the proper cup or lid dispenser models required for your particular cup and lid sizes.

Model Number	Maximum Number of Dispensers	Dimensions H x W x D
COUNTERTOP DISPENSING STAND FOR USE WITH ADJ-NW AND TLD SERIES		
EZ-3EZ	3	29" x 15" x 15"

▽ SURFACE OR STAND MOUNTED PORTION CUP & LID DISPENSERS

STAINLESS STEEL CONSTRUCTION

SFL SERIES SURFACE OR STAND MOUNT PORTION CUP & LID DISPENSERS

Stainless steel units are designed to dispense a variety of 2 oz. to 6 oz. cups, containers and matching lids.

The SFL-ADJ portion cup dispenser is top loading and self-adjusting. It is ideal for use with portion cups for condiments or dressings.

The SFL-TLD lid dispenser is front loading and requires no adjustment. This lid dispenser is an ideal complement to customers using the SFL-ADJ that require storage for portion cup lids.

Quality stainless steel construction ensures years of dispensing reliability.

All units can be mounted to a wall or any type of vertical surface. Each dispenser includes a stainless steel mounting bracket.

Countertop stands are also available. Please see below for additional information on SFL Series countertop dispensing stands.

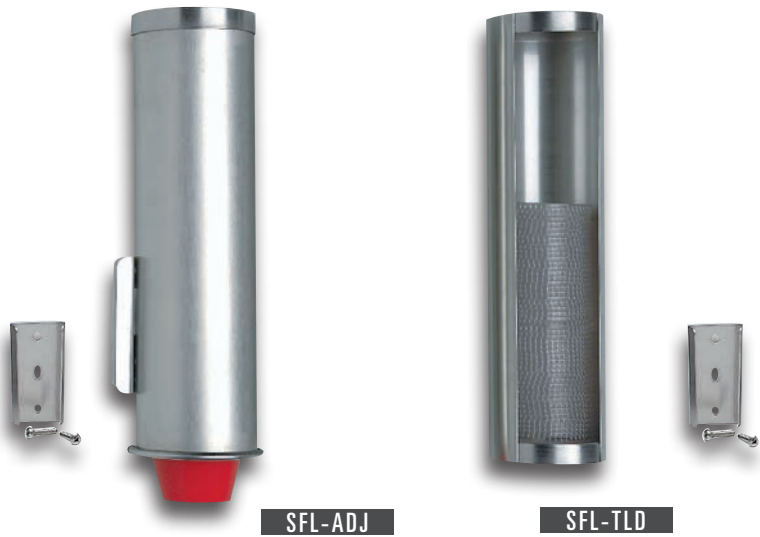

Model Number	Cup / Lid Rim Diameter	Tube Diameter	Tube Length	Paper/Plastic Sizes	Foam Sizes
SURFACE OR STAND PORTION CUP & LID DISPENSERS					
SFL-ADJ	2 $\frac{3}{8}$ "-2 $\frac{7}{8}$ "	3 $\frac{3}{8}$ "	12"	2 oz. to 6 oz.	2 oz. to 6 oz.
SFL-TLD	2"-3"	3 $\frac{1}{8}$ "	12"	2 oz. to 6 oz.	2 oz. to 6 oz.

BLACK POLYSTYRENE CONSTRUCTION

▽ COUNTERTOP STANDS FOR PORTION CUP & LID DISPENSERS



SFL-STAND-2 shown with SFL-ADJ and SFL-TLD portion cup & lid dispensers.



SFL-STAND-1



SFL-STAND-2

SFL SERIES COUNTERTOP PORTION CUP & LID DISPENSER STANDS

Countertop stands feature durable polystyrene construction. Their compact footprint provides a stable dispensing platform for the SFL-ADJ and SFL-TLD portion cup and lid dispensers. Stands are available to hold one or two dispensers.

Model Number	Number of Dispenser Attachments	Dimensions H x W x D
SFL-STAND-1	1	15" x 5" x 11 $\frac{1}{4}$ "
SFL-STAND-2	2	15" x 7 $\frac{1}{2}$ " x 11 $\frac{1}{4}$ "

▽ COUNTERTOP PORTION CUP & LID ORGANIZERS

CTCO
SERIES



CTCO-3CL



CTCO-4CL

CTCO SERIES COUNTERTOP OR WALL MOUNT PORTION CUP & LID ORGANIZERS

These portion cup and lid organizers features durable clear acrylic construction. Units can be placed on the countertop or mounted to any vertical surface utilizing the rear facing key holes. The maximum acceptable cup or lid diameter is 3".

Model Number	Item Description	Dimensions H x W x D
CTCO-3CL	3 Section Portion Cup/Lid Organizer	9 1/8" x 10" x 3 1/2"
CTCO-4CL	4 Section Portion Cup/Lid Organizer	9 1/8" x 13 1/4" x 3 1/2"

CLEAR ACRYLIC CONSTRUCTION

▽ COUNTERTOP PORTION CUP & LID DISPENSERS

CTCO
SERIES

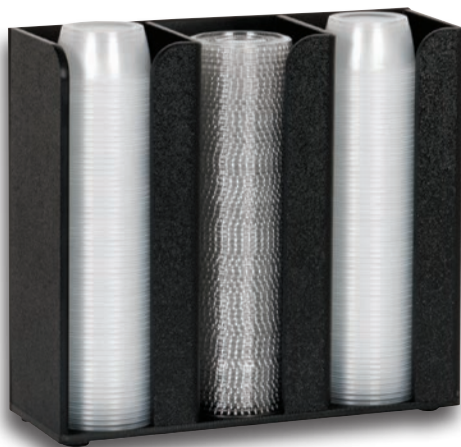

CTCO-3BT

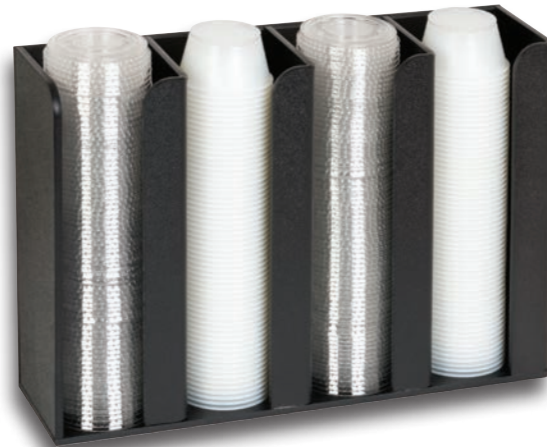

CTCO-4BT

CTCO SERIES COUNTERTOP OR WALL MOUNT PORTION CUP & LID ORGANIZERS

These portion cup and lid organizers features durable polystyrene construction. Units can be placed on the countertop or mounted to any vertical surface utilizing the rear facing key holes. The maximum acceptable cup or lid diameter is 3".

Model Number	Item Description	Dimensions H x W x D
CTCO-3BT	3 Section Portion Cup/Lid Organizer	9 1/8" x 10" x 3 1/2"
CTCO-4BT	4 Section Portion Cup/Lid Organizer	9 1/8" x 13 1/4" x 3 1/2"

BLACK POLYSTYRENE CONSTRUCTION

▽ COUNTERTOP CUP & LID ORGANIZERS

BLACK POLYSTYRENE CONSTRUCTION



The optional MSH-1 acrylic straw and condiment holder can be inserted into any section on the LID Series countertop organizers to accommodate straws, stir sticks or packeted condiments.

LID-3BT and LID-5BT organizers shown at left with optional MSH-1 straw and condiment holder.



MSH-1



LID-3BT



LID-4BT



LID-5BT

MAXIMUM DISPENSING IN A MINIMUM AMOUNT OF SPACE

LID SERIES COUNTERTOP CUP & LID ORGANIZERS

Countertop cup & lid organizers accommodate 6 oz. to 44 oz. paper, plastic or foam cups and lids with rim diameters ranging from 2 5/8" – 4 3/4".

Countertop units feature durable polystyrene construction. Compact design requires only 5 1/4" W of countertop space. The LID Series are NSF listed.

The optional MSH-1 straw and condiment holder can be inserted into any section for storing straws, stir sticks or packeted condiments.

Model Number	Item Description	Dimensions H x W x D
LID-3BT	3 Section Lid & Cup Organizer	16 1/2" x 5 1/4" x 17"
LID-4BT	4 Section Lid & Cup Organizer	19 1/2" x 5 1/4" x 20 3/4"
LID-5BT	5 Section Lid & Cup Organizer	23" x 5 1/4" x 24 1/2"
MSH-1	Modular Straw & Condiment Holder	6" x 4" x 4"

▽ COUNTERTOP CUP, LID, STRAW & CONDIMENT ORGANIZERS



DLCO-5BT



HLCO-3BT

LCO SERIES COUNTERTOP CUP, LID, STRAW & CONDIMENT ORGANIZERS

These versatile counter top polystyrene organizers offer an easy way to organize cups, lids, straws and condiments. Countertop units feature durable polystyrene construction.

Model Number	Item Description	Dimensions H x W x D
DLCO-5BT	6 Section Multipurpose Organizer	16¾" x 20¾" x 5½"
HLCO-3BT	8 Section Multipurpose Organizer	11¾" x 17" x 7½"

▽ COUNTERTOP CUP, LID, STRAW & CONDIMENT ORGANIZERS



MCD-4BT



MCD-6BT



The MCD-4BT and MCD-6BT organizers include removable front panels that allow the unit to be configured for a variety of dispensing applications.

MCD SERIES COUNTERTOP CUP, LID, STRAW & CONDIMENT ORGANIZERS

These versatile counter top polystyrene organizers offer an easy way to organize cups, lids, straws and condiments. MCD Series organizers include removable front panels for a variety of custom dispensing configurations.

Model Number	Item Description	Dimensions H x W x D
MCD-4BT	4 Section Multipurpose Organizer	11¾" x 10½" x 10"
MCD-6BT	6 Section Multipurpose Organizer	11¾" x 15" x 10"

BLACK POLYSTYRENE CONSTRUCTION

▽ LID, STRAW & CONDIMENT ORGANIZERS WITH REMOVABLE DIVIDERS



NLO-1B



WLO-1B

MAXIMUM ORGANIZATION IN A MINIMUM AMOUNT OF SPACE

The **NLO-1B** & **WLO-1B** models feature durable polystyrene construction and offer an easy way to organize lids, straws or condiments. Some section dividers are removable for custom dispensing configurations.

These units offer maximum organization in a minimum amount of countertop space.

Model Number	Item Description	Dimensions H x W x D
NLO-1B	Black Polystyrene Narrow Organizer	16½" x 8" x 20½"
WLO-1B	Black Polystyrene Wide Organizer	16½" x 15" x 20½"

BLACK POLYSTYRENE CONSTRUCTION

▽ LID, STRAW & CONDIMENT ORGANIZERS



NLO-WVL



NLO-CTVL



Ideal for use when space is limited.

MICRO-1

The **NLO-WVL**, **NLO-CTVL** & **MICRO-1** models are designed with multiple sections for custom configuration. All organizers feature durable polystyrene construction.

The **MICRO-1** model is ideal for applications where countertop space is limited.

Model Number	Item Description	Dimensions H x W x D
NLO-WVL	Black Polystyrene Organizer	20¼" x 11½" x 21¼"
NLO-CTVL	Black Polystyrene Organizer	20" x 13½" x 22½"
MICRO-1	Black Polystyrene Organizer	4⅝" x 8" x 11⅞"

▽ LID, STRAW & CONDIMENT ORGANIZERS

NLS
SERIES

BLACK POLYSTYRENE CONSTRUCTION



NLS-1BT



WLS-1BT



NSLC-1BT

The **NLS-1BT**, **WLS-1BT** & **NSLC-1BT** models feature a sleek design and an easy to clean ABS plastic top. All organizers feature durable polystyrene construction.

The NSLC-1BT model includes a stainless steel CMND-1 napkin dispenser which accommodates full fold napkin sizes ranging from 4½"–5" x 6½".

Model Number	Item Description	Dimensions H x W x D
NLS-1BT	Black Polystyrene Narrow Organizer	9½" x 8½" x 23½"
WLS-1BT	Black Polystyrene Wide Organizer	9½" x 16½" x 23"
NSLC-1BT	Black Polystyrene w/Napkin Dispenser	15¾" x 8½" x 24½"

▽ LID, STRAW & CONDIMENT ORGANIZERS

NLS
SERIES

STAINLESS STEEL CONSTRUCTION



NLS-1

accepts up to
64 oz. lids



WLS-1

The **NLS-1** & **WLS-1** models feature stainless steel welded construction and an easy to clean ABS plastic top. The models are ideal for merchandising single-serve coffee, tea and hot chocolate packets or simply organizing lids, straws, stir sticks and condiments.

Model Number	Item Description	Dimensions H x W x D
NLS-1	Stainless Steel Narrow Organizer	11½" x 8½" x 22½"
WLS-1	Stainless Steel Wide Organizer	11½" x 16½" x 22¼"

▽ LID, STRAW, CONDIMENT & FLATWARE ORGANIZERS WITH NAPKIN DISPENSER



NLO-LDNH



NLO-ADNH



NLO-SWNH

NLO SERIES COUNTERTOP LID, STRAW, CONDIMENT, NAPKIN & FLATWARE ORGANIZERS

Countertop units feature durable polystyrene construction. These unique units offer maximum organization in a minimum amount of space.

The CT-FULL-BS full fold napkin dispenser accommodates napkin sizes 4½"-5" x 6½".

Model Number	Item Description	Dimensions H x W x D
NLO-LDNH	Multi-Purpose Polystyrene Organizer	14½" x 8½" x 17"
NLO-ADNH	Multi-Purpose Polystyrene Organizer	14½" x 8½" x 17"
NLO-SWNH	Organizer with Flatware Holders	14¾" x 10" x 17"

▽ COUNTERTOP BOTTLE HOLDERS



CTBH-4BT



CTBH-8BT



CTBH-12BT

CTBH SERIES COUNTERTOP BOTTLE HOLDERS

Countertop units feature durable polystyrene construction. Individual sections accommodate bottle sizes up to 3¾" diameter.

Multiple units can be placed next to each other to create additional custom configurations with additional capacity.

Model Number	Item Description	Dimensions H x W x D
CTBH-4BT	4 Section Bottle Holder	9½" x 6" x 17"
CTBH-8BT	8 Section Bottle Holder	9½" x 9½" x 17"
CTBH-12BT	12 Section Bottle Holder	9½" x 13¼" x 17"

BLACK POLYSTYRENE CONSTRUCTION



CTSH-6BT



CTSH-8BT



SWCH-1BT

CTSH & SWCH-1BT COUNTERTOP FLATWARE & CONDIMENT ORGANIZERS

Countertop units feature durable polystyrene construction. These unique units offer maximum organization in a minimum amount of space. All models include removable perforated plastic inserts. The SWCH-1BT organizer has removable section dividers for custom configurations.

Model Number	Item Description	Dimensions H x W x D
CTSH-6BT	6 Compartment Organizer	13" x 10 $\frac{1}{8}$ " x 15 $\frac{3}{8}$ "
CTSH-8BT	8 Compartment Organizer	15 $\frac{3}{4}$ " x 10 $\frac{1}{8}$ " x 18 $\frac{3}{4}$ "
SWCH-1BT	13 Compartment Multi-Purpose Organizer	16 $\frac{5}{8}$ " x 10" x 21"



VSCH-3BT



VSCH-6BT



VSCH-8BT

VSCH SERIES COUNTERTOP FLATWARE & CONDIMENT ORGANIZERS

Countertop units feature durable polystyrene construction. All models include removable perforated plastic inserts.

Multiple units can be placed next to each other to create additional custom configurations with additional capacity.

Model Number	Item Description	Dimensions H x W x D
VSCH-3BT	3 Compartment Organizer	21 $\frac{1}{8}$ " x 6" x 9 $\frac{1}{4}$ "
VSCH-6BT	6 Compartment Organizer	21 $\frac{1}{8}$ " x 10 $\frac{1}{2}$ " x 9 $\frac{1}{4}$ "
VSCH-8BT	8 Compartment Organizer	28 $\frac{1}{8}$ " x 10 $\frac{1}{2}$ " x 9 $\frac{1}{4}$ "

BLACK POLYSTYRENE CONSTRUCTION

▽ COUNTERTOP CUP, LID, STRAW & CONDIMENT ORGANIZERS



CLCO-2BT



CLCO-4BT

CLCO SERIES COUNTERTOP CUP, LID, STRAW & CONDIMENT ORGANIZERS

Countertop units feature durable polystyrene construction. These units can be used to organize cups, lids, condiments and straws or stir sticks.

The maximum acceptable cup or lid diameter is 4¼".

Model Number	Item Description	Dimensions H x W x D
CLCO-2BT	4 Compartment Cup & Lid Organizer	11½" x 9½" x 14½"
CLCO-4BT	8 Compartment Cup & Lid Organizer	11½" x 18¾" x 14½"

▽ COUNTERTOP REVOLVING CUP & LID ORGANIZERS

Model Number	Item Description	Dimensions H x W x D
RCLO-SM-4BT	4 Section Portion Cup / Lid Organizer	13¼" x 7" x 7"
RCLO-LG-4BT	4 Section Cup / Lid Organizer	18¼" x 9½" x 9½"

RCLO-SM-4BT COUNTERTOP REVOLVING PORTION CUP & LID ORGANIZER

Revolving portion cup & lid organizer features durable polystyrene construction. A built in spinning carousel provides easy access to all four cup or lid compartments.

The maximum acceptable portion cup or lid diameter is 3".

RCLO-LG-4BT COUNTERTOP REVOLVING CUP & LID ORGANIZER

Revolving cup & lid organizer features durable polystyrene construction. A built in spinning carousel provides easy access to all four cup or lid compartments.

The maximum acceptable cup or lid diameter is 4¼".



RCLO-SM-4BT



RCLO-LG-4BT

BLACK POLYSTYRENE CONSTRUCTION

▽ COUNTERTOP VERTICAL CONDIMENT ORGANIZERS



CTVH-4BT

CTVH-5BT

CTVH SERIES COUNTERTOP VERTICAL CONDIMENT ORGANIZERS

Countertop units feature durable polystyrene construction. These unique units offer maximum organization in a minimum amount of space.

Organizers can be used to organize a variety of packeted condiments. Canisters can be placed on the top shelf of each unit.

Available with four or five sections these organizers require only 6 1/8" W of countertop space.

High capacity organizers are ideal for use in large volume foodservice operations. Multiple units can be placed next to each other to create additional storage capacity.

Model Number	Item Description	Dimensions H x W x D
CTVH-4BT	4 Section Condiment Organizer	20 3/8" x 6 5/8" x 11 1/8"
CTVH-5BT	5 Section Condiment Organizer	26 3/8" x 6 5/8" x 13 1/2"

▽ COUNTERTOP CUP, LID, STRAW & CONDIMENT ORGANIZER



SLR-SCL-1BT

SLR-SCL-1BT COUNTERTOP CUP, LID, STRAW & CONDIMENT ORGANIZER

Countertop combination cup, lid, straw & condiment organizer features durable polystyrene construction. Unique cabinet design incorporates an integrated top organizer to provide storage for lids, straws, stir-sticks and condiment packets.

The short cabinet depth and compact overall design makes this item ideal for areas with limited space. This item is great for breakrooms, kitchens, refreshment centers or a variety of portable dispensing applications.

The included SLR-2S cup dispenser is for use with 8 oz. to 44 oz. paper, plastic or foam cups with rim diameters ranging from 3"-4 1/2".

Maximum acceptable lid diameter is 4 1/4". Maximum straw length is 9".

Model Number	Item Description	Dimensions H x W x D
SLR-SCL-1BT	Cup, Lid, Straw & Condiment Organizer	14 1/2" x 9 1/2" x 18 1/2"

BLACK POLYSTYRENE CONSTRUCTION

REINFORCED WELDED WIRE CONSTRUCTION

The optional WR-CT-LID insert is available for WR-CT Series cup dispensing racks. This polystyrene lid chute creates a storage area for lids up to 4 3/8" diameter. Multiple inserts can be utilized in a single dispensing rack.

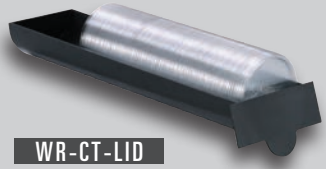

WR-CT-LID

WR-CT-4 shown with optional WR-CT-LID



WR-CT-3



WR-CT-4



WR-CT-5

MAXIMUM DISPENSING IN A MINIMUM AMOUNT OF SPACE

WR-CT SERIES CUP & LID DISPENSING RACKS

These units dispense 6 oz. to 44 oz. paper, plastic or foam cups with rim diameters ranging from 2 5/8" – 4 3/8". Features the simple and fast EZ-Twist adjustment mechanism. Reinforced welded construction and durable powder coated finish provide long term reliability.

The optional WR-CT-LID insert creates a storage area for lids up to 4 3/8" diameter.

Model Number	Item Description	Dimensions H x W x D
WR-CT-3	3 Section Vertical Dispensing Rack	19 1/4" x 6 1/4" x 20"
WR-CT-4	4 Section Vertical Dispensing Rack	24 3/4" x 6 1/4" x 20"
WR-CT-5	5 Section Vertical Dispensing Rack	29 3/4" x 6 1/4" x 20"
WR-CT-LID	1 Section Optional Lid Insert	3 1/4" x 6 1/8" x 20"

▽ COUNTERTOP WIRE CUP, LID & STRAW DISPENSING RACKS

**WR
SERIES**

REINFORCED WELDED WIRE CONSTRUCTION

Model Number	Item Description	Dimensions H x W x D
WR-3	3 Sections: (1) 3½"; (1) 4¼"; (1) 4¾"	8½" x 14½" x 5"
WR-4	4 Sections: (4) 4¼"	8½" x 18½" x 5"
WR-5	5 Sections: (1) 3½"; (2) 4¼"; (2) 4¾"	8½" x 23" x 5"
WR-STAND	Optional Angled Stand for WR Series	11" x 5¾" x 15"
WR-STRAW	Optional Straw Holder for WR Series	4¾" x 3½"

WR SERIES COUNTERTOP CUP & LID ORGANIZERS

These versatile wire racks accommodate a variety of cup & lid sizes and offer maximum organization in a minimum amount of counter space. Units are available with three, four and five sections and can be used for either cups or lids.

Organizers may be ordered with the optional WR-STAND and/or WR-STRAW holder shown below.



WR-3



WR-4



WR-5

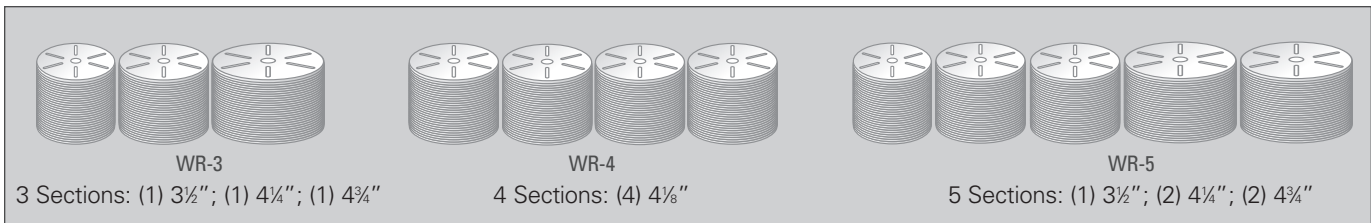

Key Features ▾

- Simple organized presentation
- Reinforced welded wire construction
- Durable black powder coated finish
- Optional WR-STAND allows easy access to all compartments
- Optional WR-STRAW unit available
- Maximum dispensing in a minimal amount of space

▽ SURFACE MOUNT OVERHEAD WIRE CUP DISPENSING RACK

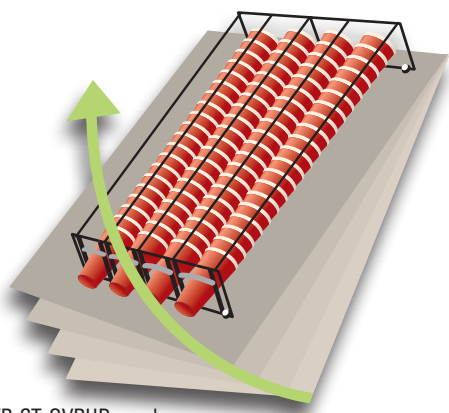

WR-CT-OVRHD can be mounted overhead in various angled mounting positions.



WR-CT-OVRHD

MAXIMUM DISPENSING IN A MINIMUM AMOUNT OF SPACE

WR-CT-OVRHD SURFACE MOUNT DISPENSING RACK
Overhead wire cup dispenser rack accommodates 6 oz. to 44 oz. paper, plastic or foam cups with rim diameters ranging from 2½" – 4¾". Unique design allows for various angled mounting and overhead positions.

Model Number	Item Description	Dimensions H x W x D
WR-CT-OVRHD	Surface Mount Cup Dispenser Rack	6⅞" x 26¼" x 18½"

▽ SURFACE MOUNT WIRE CUP DISPENSING RACK

WR-CC-22 shown below with the optional WR-CC-22BKT

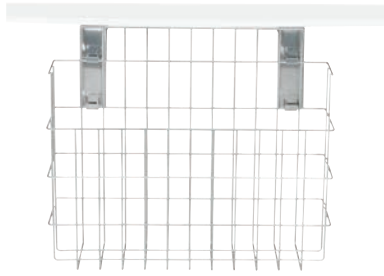

The optional WR-CC-22BKT under counter bracket kit includes two stainless steel quick release mounting brackets. These brackets allow the WR-CC-22 to be removed quickly and provide easy access to areas behind the cup caddy.

WR-CC-22BKT



WR-CC-22

WR-CC-22 SURFACE MOUNT CUP CADDY
This stainless steel electropolished wire rack stores cups and containers up to 5" in diameter and mounts easily to any flat 22" wide vertical surface.
Optional WR-CC-22BKT bracket kit allows unit to be quickly and easily removed without tools.

Model Number	Item Description	Dimensions H x W x D
WR-CC-22	Stainless Steel Wire Cup Caddy	19" x 22" x 5½"
WR-CC-22BKT	Optional Bracket Kit for WR-CC-22	7" x 2¼" x 7½"

Model Number	Item Description	Dimensions H x W x D
WR-COND-3	3 Compartment Organizer	18 ³ / ₈ " x 5 ³ / ₄ " x 15 ³ / ₄ "
WR-COND-6	6 Compartment Organizer	18 ³ / ₈ " x 11 ¹ / ₂ " x 15 ³ / ₄ "
WR-BOTL-3	3 Section Bottle Holder	7 ¹ / ₂ " x 4 ¹ / ₄ " x 13 ¹ / ₄ "
WR-BOTL-6	6 Section Bottle Holder	7 ¹ / ₂ " x 9" x 13 ¹ / ₄ "

WR-COND & WR-BOTL SERIES ORGANIZERS

Countertop wire organizers accommodate a variety of dispensing applications. WR-COND Series organizers include removable plastic storage bins. WR-BOTL Series organizers accommodate most standard bottle sizes up to 3³/₈" diameter.

Reinforced welded construction and durable powder coated finish provide long term reliability. Units can be attached together to create a variety of dispensing configurations.



WR-COND-3



WR-COND-6



WR-BOTL-3



WR-BOTL-6

MAXIMUM DISPENSING IN A MINIMUM AMOUNT OF SPACE



WR-COND and WR-BOTL Series organizers can be attached together to create a variety of dispensing configurations. Any number of units can be attached for additional capacity.

Key Features ▾

- Simple organized presentation
- Reinforced welded wire construction
- Durable black powder coated finish
- WR-COND bins are easily removable
- WR-BOTL fits bottles up to 3³/₈"
- Units can be easily attached for additional capacity
- Maximum dispensing in a minimal amount of space

REINFORCED WELDED WIRE CONSTRUCTION



MAXIMUM DISPENSING IN A MINIMUM AMOUNT OF SPACE

PL-CT SERIES COUNTERTOP OR SURFACE MOUNT CUP & LID DISPENSING CABINETS

Cup Dispensing Cabinets accommodate 6 oz. to 44 oz. paper, plastic or foam cups with rim diameters ranging from 2½" – 4¾".

These unique spring-loaded models feature the simple and fast EZ-Twist adjustment mechanism. The divided straw compartment can be used for packeted condiments and/or stir sticks.

The PL-CT-LID lid and condiment organizer requires minimal countertop space. Compact design requires only 5½" W x 20¼" D of countertop space.

All PL-CT Series cup dispensing cabinets include key holes in the side panel for mounting to a vertical surface (mounting hardware is not included).

Model Number	Item Description	Dimensions H x W x D
PL-CT-LID	5 Section Lid & Condiment Organizer	17½" x 5½" x 19"
PL-CT-3BT	3 Section Cup Dispensing Cabinet	16¼" x 5½" x 20¼"
PL-CT-4BT	4 Section Cup Dispensing Cabinet	21¼" x 5½" x 20¼"
PL-CT-5BT	5 Section Cup Dispensing Cabinet	26¾" x 5½" x 20¼"

▽ COUNTERTOP CONDIMENT, DOME LID & STRAW ORGANIZERS

**HVCD
TLO
SERIES**

Model Number	Item Description	Dimensions H x W x D
HVCD-3BT	3 Section Condiment Organizer	24¼" x 6½" x 14"
HVCD-4BT	4 Section Condiment Organizer	32¼" x 6½" x 14"
TLO-DL-3BT	3 Section Dome Lid & Straw Organizer	24¼" x 6½" x 14"
TLO-DL-4BT	4 Section Dome Lid & Straw Organizer	32¼" x 6½" x 14"

HVCD SERIES CONDIMENT PACKET ORGANIZERS

Countertop organizers feature durable polystyrene construction and provide maximum condiment storage in a minimum amount of space.

TLO-DL SERIES DOME LID & STRAW ORGANIZERS

Countertop dome lid and straw organizers feature durable polystyrene construction. Large openings provide easy accessibility to all dome lid sizes. High capacity straw sections handle standard and jumbo length straws.



HVCD-3BT

HVCD-4BT

TLO-DL-3BT

TLO-DL-4BT

BLACK POLYSTYRENE CONSTRUCTION



Maximum acceptable lid diameter is 4 3/4"



TLO-3SS



TLO-4SS

TLO SERIES COUNTERTOP LID & STRAW ORGANIZERS

Countertop lid and straw organizers feature quality stainless steel with reinforced welded construction. Units include angled lid compartments and a divided section for standard and jumbo length straws or condiments. Available with three or four lid sections these cabinets occupy only 6 1/2" x 14" of countertop space.

Model Number	Item Description	Dimensions H x W x D
TLO-3SS	3 Section Stainless Steel Organizer	24 1/2" x 6 1/2" x 14"
TLO-4SS	4 Section Stainless Steel Organizer	32 1/2" x 6 1/2" x 14"

▽ COUNTERTOP LID & STRAW ORGANIZERS

TLO
SERIES

Model Number	Item Description	Dimensions H x W x D
TLO-2BT	2 Section Polystyrene Organizer	16¼" x 6½" x 14"
TLO-3BT	3 Section Polystyrene Organizer	24¼" x 6½" x 14"
TLO-4BT	4 Section Polystyrene Organizer	32¼" x 6½" x 14"

TLO SERIES COUNTERTOP LID & STRAW ORGANIZERS

Countertop lid and straw organizers feature durable polystyrene construction. Units include angled lid compartments and a divided section for standard and jumbo length straw or condiments. Available with two, three or four lid sections these cabinets occupy only 6½" x 14" of countertop space.

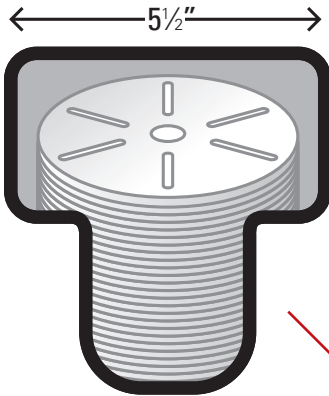

Maximum acceptable lid diameter is 5½"



TLO-2BT



TLO-3BT



TLO-4BT

BLACK POLYSTYRENE CONSTRUCTION

▽ **COUNTERTOP OR SURFACE MOUNT CUP, LID & STRAW ORGANIZERS**

STAINLESS STEEL CONSTRUCTION

Model Number	Item Description	Dimensions H x W x D
CTLD-15	3 Section Adjustable Organizer	8" x 15½" x 5"
CTLD-15A	3 Section Adjustable Organizer with SH-1	8" x 19⅝" x 5"
CTLD-19	4 Section Adjustable Organizer	8" x 19½" x 5"
CTLD-19A	4 Section Adjustable Organizer with SH-1	8" x 23⅝" x 5"
CTLD-22	5 Section Adjustable Organizer	8" x 22½" x 5"
CTLD-22A	5 Section Adjustable Organizer with SH-1	8" x 26⅝" x 5"
SH-1	Optional Straw Holder for CTLD	5" x 4⅛" x 5"
TSD-1S	Surface Mounted Straw Holder	6" H x 3½" Dia.

CTLD SERIES CUP, LID & STRAW ORGANIZERS

Countertop or surface mount units feature quality stainless steel construction and adjustable dividers to accommodate multiple cup & lid sizes. Each model can be ordered with or without the optional SH-1 Straw Holder.



CTLD-15

CTLD-15A

CTLD-19

CTLD-19A

CTLD-22

CTLD-22A

▽ **COUNTERTOP CUP, LID & STRAW ORGANIZERS**



CTHL-3



CTHL-4



MSH-1

CTHL & MSH SERIES COUNTERTOP CUP, LID & STRAW ORGANIZERS

Stylish and versatile clear plastic organizers provide for simple storage of cups, lids and straws.

All CTHL Series models can be used in countertop or surface mounted applications.

Model Number	Item Description	Dimensions H x W x D
CTHL-3	3 Sections: Two 4" & One 5"	8" x 13¼" x 5½"
CTHL-4	4 Sections: Three 4" & One 5"	8" x 17¾" x 5½"
MSH-1	4" Modular Straw Holder	6" x 4" x 4"

▽ **COUNTERTOP CUP & LID ORGANIZERS**



MLD-1



MLD-2

MLD SERIES COUNTERTOP CUP & LID ORGANIZERS

Clear plastic modular organizers allow for storage of cups or lids. The small footprint allows for flexible placement in any area.

Model Number	Item Description	Dimensions H x W x D
MLD-1	4" Modular Cup or Lid Holder	8" x 4" x 4"
MLD-2	5" Modular Cup or Lid Holder	8" x 5" x 5"

▽ **COUNTERTOP MOBILE ORDER PICK-UP UNIT**



MOPU-3B

MOPU-3B COUNTERTOP MOBILE ORDER PICK-UP UNIT

This high quality black acrylic organizer is an ideal way to organize and display customer beverage and food orders that are waiting to be picked up.

Holds 8 oz. to 44 oz. paper, plastic or foam cups and/or small bags. Three tiered shelf design provides customer visibility. Includes non-skid rubber feet.

Model Number	Item Description	Dimensions H x W x D
MOPU-3B	3 Tier Mobile Order Pick-up Unit	12" x 16½" x 14"



FMVL-1



FMVL-2



FMVL-3



FMVL-4



FMVDL-3



FMVS-1



FMN-1



FMN-1BT

TEXTURED BLACK POLYSTYRENE CONSTRUCTION

Model Number	Item Description	Dimensions H x W x D	Cut-Out Dimensions
FMVL-1	Built-in 1 Section Lid Organizer	7" x 7" x 5½"	5¼" x 5½"
FMVL-2	Built-in 2 Section Lid Organizer	18" x 7" x 5½"	16¼" x 5½"
FMVL-3	Built-in 3 Section Lid Organizer	26" x 7" x 5½"	24½" x 5½"
FMVL-4	Built-in 4 Section Lid Organizer	33¾" x 7" x 5½"	32¾" x 5½"
FMVDL-3	Built-in 3 Section Dome Lid & Straw Organizer	26" x 7" x 8"	24½" x 5½"
FMTS-1BT	Built-in 1 Section Straw Organizer	6¼" x 11½" x 5½"	5½" x 10½"
FMVS-1	Built-in 1 Section Straw Organizer	6" x 7" x 12¼"	4½" x 5½"
FMN-1BT	Built-in Dispenser - 4½"-5" x 6½" Napkins	6¼" x 8½" x 5½"	5¼" x 7½"



FML-2

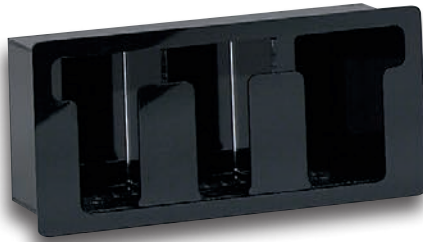

FML-3



FML-4



FMC-4



FMC-7

GLOSS BLACK ACRYLIC CONSTRUCTION



FMN-1



FMN-2

GLOSS BLACK ACRYLIC CONSTRUCTION

Model Number	Item Description	Dimensions H x W x D	Cut-Out Dimensions
FML-2	Built-in 2 Section Lid Organizer	7¼" x 11" x 5½"	6¼" x 10"
FML-3	Built-in 3 Section Lid Organizer	7¼" x 16" x 5½"	6¼" x 15"
FML-4	Built-in 4 Section Lid Organizer	7¼" x 21" x 5½"	6¼" x 20"
FMC-4	Built-in 4 Section Condiment Organizer	7¼" x 12" x 5½"	6¼" x 11"
FMC-7	Built-in 7 Section Condiment Organizer	7¼" x 20" x 5½"	6¼" x 19"
FMN-1	Built-in Dispenser - 4½"-5" x 6½" Napkins	6¼" x 8½" x 5½"	5¼" x 7½"
FMN-2	Built-in Dispenser - 3½"-4" x 6½" Napkins	5¼" x 8½" x 5½"	4¼" x 7½"

▽ UNDER COUNTER CUP DISPENSER MOUNTING BRACKETS

BLACK POLYSTYRENE CONSTRUCTION



UCMB-1BT



UCMB-2BT



UCMB-3BT



UCMB-2BT under counter mounting bracket shown above with two SLR-2 Series in-counter cup dispensers (not included) installed. UCMB Series brackets allows for installation to any flat surface.

▽ UCMB Bracket Cup Dispenser Compatibility



STL-2

SLR-2

BFL-2

ADJ-2

All **DISPENSE-RITE** one-size-fits-all cup dispenser models are compatible with UCMB Series under counter mounting brackets. This includes any STL-2, SLR-2, BFL-2 and/or ADJ-2 Series in-counter cup dispenser.

GREAT FOR MOUNTING IN-COUNTER CUP DISPENSERS UNDER THE COUNTER

UCMB SERIES UNDER COUNTER CUP DISPENSER MOUNTING BRACKETS

Under counter mounting brackets feature durable polystyrene construction. These unique brackets will allow you to mount one or more one-size-fits-all in-counter cup dispensers to any flat surface.

Brackets are available to mount one, two or three STL-2, SLR-2, BFL-2 and/or ADJ-2 Series cup dispensers.

The maximum acceptable counter lip is 1-5/8"H.

Model Number	Item Description	Dimensions H x W x D
UCMB-1BT	1 Hole Under Counter Bracket	9½" x 8" x 5"
UCMB-2BT	2 Hole Under Counter Bracket	9½" x 15½" x 5"
UCMB-3BT	3 Hole Under Counter Bracket	9½" x 23½" x 5"

▽ **BUILT-IN FLUSH MOUNT FLATWARE ORGANIZERS**



FMSH-2BT



FMSH-3BT

**FMSH SERIES BUILT-IN
FLUSH MOUNT FLATWARE ORGANIZERS**

Built-in flatware organizers feature durable polystyrene construction.

Includes removable perforated plastic inserts which can hold plastic cutlery, silverware or condiment packets.

Model Number	Item Description	Dimensions H x W x D	Cut-Out Dimensions
FMSH-2BT	2 Section Flatware Organizer	7½" x 12⅞" x 8¾"	6¾" x 11⅞"
FMSH-3BT	3 Section Flatware Organizer	7½" x 17⅞" x 8¾"	6¾" x 16⅞"

▽ **BUILT-IN FLUSH MOUNT STRAW ORGANIZERS**



FMVS-2SBT



FMVS-2LBT

**FMVS SERIES BUILT-IN
FLUSH MOUNT STRAW ORGANIZERS**

Built-in straw organizers feature durable polystyrene construction.

Available for standard and jumbo length straws.

Model Number	Item Description	Dimensions H x W x D	Cut-Out Dimensions
FMVS-2SBT	2 Section Standard Straw Organizer	7¼" x 6½" x 9½"	6⅝" x 5⅝"
FMVS-2LBT	2 Section Jumbo Straw Organizer	7¼" x 6½" x 11"	6⅝" x 5⅝"

BLACK POLYSTYRENE CONSTRUCTION

▽ BUILT-IN FLUSH MOUNT TRASH DOORS



FMTD-1BT



FMTD-2BT



FMTD-3BT

FMTD SERIES BUILT-IN FLUSH MOUNT TRASH DOORS

Built-in trash doors feature quality polystyrene construction. Units have smooth edges and a gravity fed self closing door.

Trash doors are available in small, medium and large widths for a variety of counter configurations.

Model Number	Item Description	Dimensions H x W x D	Cut-Out Dimensions
FMTD-1BT	Built-in Small Flush Mount Trash Door	7½" x 10⅝" x 2¼"	6⅞" x 9⅓⅛"
FMTD-2BT	Built-in Medium Flush Mount Trash Door	7½" x 13¼" x 2¼"	6⅞" x 12⅝⅛"
FMTD-3BT	Built-in Large Flush Mount Trash Door	7½" x 17⅝" x 2¼"	6⅞" x 16⅓⅛"

▽ BUILT-IN FLUSH MOUNT RECYCLE DOORS



FMRD-1BT



FMRD-2BT



FMRD-3BT

FMRD SERIES BUILT-IN FLUSH MOUNT RECYCLE DOORS

Built-in recycle doors feature quality polystyrene construction. Units have smooth edges and a gravity fed self closing door.

Recycle doors are available in small, medium and large widths for a variety of counter configurations.

Model Number	Item Description	Dimensions H x W x D	Cut-Out Dimensions
FMRD-1BT	Built-in Small Flush Mount Recycle Door	7½" x 10⅝" x 2¼"	6⅞" x 9⅓⅛"
FMRD-2BT	Built-in Medium Flush Mount Recycle Door	7½" x 13¼" x 2¼"	6⅞" x 12⅝⅛"
FMRD-3BT	Built-in Large Flush Mount Recycle Door	7½" x 17⅝" x 2¼"	6⅞" x 16⅓⅛"

BLACK POLYSTYRENE CONSTRUCTION

▽ BUILT-IN FLUSH MOUNT TISSUE DISPENSER & BAG ORGANIZER

**FMT-1BT BUILT-IN
FLUSH MOUNT TISSUE DISPENSER**

Built-in tissue dispenser features quality polystyrene construction. Accepts most midget size waxed paper tissues. Two box system combines easy loading and simple installation in the counter.



FMT-1BT



FMB-1BT

**FMB-1BT BUILT-IN
FLUSH MOUNT BAG ORGANIZER**

Built-in bag organizer features quality polystyrene construction. Two compartment organizer accepts a variety of bags up to 9" wide.

Model Number	Item Description	Dimensions H x W x D	Cut-Out Dimensions
FMT-1BT	Built-in Flush Mount Tissue Dispenser	8" x 8¼" x 3½"	7½" x 7⅞"
FMB-1BT	Built-in Flush Mount Bag Organizer	7½" x 10⅝" x 11½"	5¼" x 9⅞"

▽ DROP-IN TRASH CHUTES



TTC-2BT



TTC-3BT



TTC-4BT

Model Number	Item Description	Dimensions H x Diameter	Cut-Out Dimensions
TTC-2BT	Drop-in Small Trash Chute	6⅞" x 7¼"	6¼"
TTC-3BT	Drop-in Medium Trash Chute	6⅞" x 9¼"	8¼"
TTC-4BT	Drop-in Large Trash Chute	6⅞" x 11¼"	10¼"

**TTC SERIES
TRASH CHUTES**

Drop-in trash chutes feature quality polystyrene construction. Units have smooth edges and an open bottom.

Units are available in small, medium and large diameter sizes for a variety of counter configurations and trash receptacle sizes.

BLACK POLYSTYRENE CONSTRUCTION

▽ BUILT-IN NAPKIN DISPENSERS

STAINLESS STEEL CONSTRUCTION



CMND-1V

CMND SERIES BUILT-IN FULL FOLD NAPKIN DISPENSERS

Built-in napkin dispensers feature quality stainless steel construction.

Units are available for horizontal or vertical dispensing applications.

The CMND Series dispenses full fold napkin sizes 4½"–5" x 6½".



CMND-1

Model Number	Item Description	Dimensions H x W x D	Cut-Out Dimensions
CMND-1V	Built-in Vertical Napkin Dispenser	6⅞" x 8¾" x 12⅞"	5¼" x 7"
CMND-1	Built-in Horizontal Napkin Dispenser	6⅞" x 8¾" x 12⅞"	5¼" x 7"

▽ TABLETOP & COUNTERTOP NAPKIN DISPENSERS

Model Number	Item Description	Dimensions H x W x D	Napkin Sizes H x W
TT-LOW-BS	Tabletop Low Fold Napkin Dispenser - 2 Sided	5⅝" x 4" x 4¾"	4⅞" x 3½"
TT-MINI-BS	Tabletop Mini Fold Napkin Dispenser - 2 Sided	4½" x 7½" x 6"	3¾" x 6½"
TT-FULL-BS	Tabletop Full Fold Napkin Dispenser - 2 Sided	5⅝" x 7½" x 6¼"	4½"–5" x 6½"
CT-MINI-BS	Countertop Mini Fold Napkin Dispenser - 1 Sided	4½" x 7⅝" x 11¾"	3¾" x 6½"
CT-FULL-BS	Countertop Full Fold Napkin Dispenser - 1 Sided	5⅝" x 7⅝" x 11¾"	4½"–5" x 6½"



TT-LOW-BS



TT-MINI-BS



TT-FULL-BS



CT-MINI-BS



CT-FULL-BS

BRUSHED SATIN STEEL FINISH

▽ DROP-IN CONDIMENT & STRAW ORGANIZERS

**TCD
SERIES**

TCD SERIES & TSD-1C CONDIMENT & STRAW ORGANIZERS

Condiment and straw organizers feature quality stainless steel construction.

The TCD Series units have a welded bottom cap which eliminates sharp edges. These units are designed for a drop in application.

The TSD-1C includes a stainless quick release mounting collar for secure installation in the counter.



TCD-1



TCD-2



TSD-1C

Model Number	Item Description	Dimensions H x Diameter	Cut-Out Dimensions
TCD-1	Drop-in Small Condiment Holder	6¼" x 6¾"	5⅝"
TCD-2	Drop-in Large Condiment Holder	6¼" x 7⅝"	6¼"
TSD-1C	Built-in Straw Holder with Mounting Collar	6" x 5⅝"	4"

▽ DROP-IN TRASH CHUTES



TCD-2-NB

Hemmed bottom, no sharp edges



TCD-3-NB



TCD SERIES TRASH CHUTES

Drop-in trash chutes feature quality stainless steel construction.

All units have smooth edges and a hemmed bottom eliminates any potential for sharp edges.

Units are available in small and medium diameter sizes.

Model Number	Item Description	Dimensions H x Diameter	Cut-Out Dimensions
TCD-2-NB	Drop-in Small Trash Chute	6" x 7⅝"	6¼"
TCD-3-NB	Drop-in Medium Trash Chute	6" x 9⅝"	8¼"

STAINLESS STEEL CONSTRUCTION

▽ COUNTERTOP OR SURFACE MOUNTED BEVERAGE ORGANIZER



PCH-4B

PCH-4B Personal Beverage Organizer is ideal for use in the following areas:

- Back of House
- Employee Breakrooms
- Cashier Counters
- Sports Complexes
- Drive Thru Areas
- Entertainment Venues

PCH-4B COUNTERTOP OR SURFACE MOUNT PERSONAL BEVERAGE ORGANIZER

This personal beverage organizer can be used to hold a variety of personal beverage containers such as cups, plastic bottles, thermoses and mugs. It is sanitary, economical, durable and easy to clean. The maximum container bottom diameter is 3½".

Model Number	Item Description	Dimensions H x W x D
PCH-4B	4 Section Personal Beverage Organizer	5" x 20" x 5"

BLACK POLYSTYRENE CONSTRUCTION

▽ COUNTERTOP CONDIMENT, LID & COFFEE ORGANIZERS



VCO-3

VCO-4



VCO-6



VCO-INS

The optional VCO-INS acrylic insert can be placed into the top section of all VCO Series countertop organizers to accommodate straws and/or stir sticks.

VCO-3 organizer shown at right with optional VCO-INS straw and stir stick insert.



VCO SERIES VERTICAL ORGANIZERS

Countertop units feature durable polystyrene construction and are ideal for use with condiments or lids.

Model Number	Item Description	Dimensions H x W x D
VCO-3	3 Section Vertical Organizer	16" x 5¼" x 6½"
VCO-4	4 Section Vertical Organizer	21" x 5¼" x 6½"
VCO-6	6 Section Vertical Organizer	16" x 10 ⅛" x 6½"
VCO-INS	Optional 2 Section Divided Insert	4¾" x 4¾" x 6¼"

▽ COUNTERTOP CONDIMENT ORGANIZER



GFBO-4BT

Model Number	Item Description	Dimensions H x W x D
GFBO-4BT	4 Section Condiment Organizer	16¾" x 17" x 10"

GFBO-4BT COUNTERTOP CONDIMENT ORGANIZER

This versatile four section high capacity packeted condiment organizer features durable polystyrene and acrylic construction.

Condiment packets are loaded in the top of the unit and dispensed out the bottom first in first out.

Four large compartments provide ample packeted condiment storage for all dispensing applications.

▽ COUNTERTOP DOME LID DISPENSERS

Model Number	Item Description	Dimensions H x W x D
FDL-3	3 Section Flat Dome Lid Dispenser	9" x 5" x 14½"
ADL-3	3 Section Angled Dome Lid Dispenser	11¾" x 5½" x 14½"

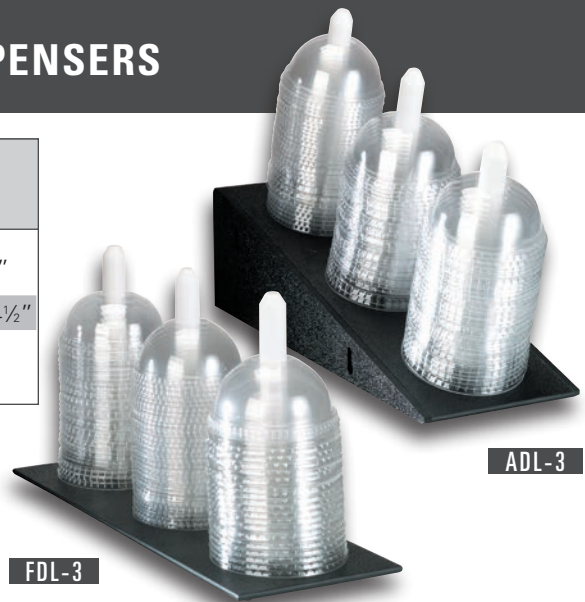

FDL-3

ADL-3

FDL-3 & ADL-3 COUNTERTOP DOME LID DISPENSERS

The FDL-3 and ADL-3 are designed for use with all dome lid sizes. The ADL-3 features an angled design for improved accessibility and can be surface or counter mounted.

▽ COUNTERTOP COFFEE SLEEVE DISPENSERS



SLV-H-1CL

SLV-H-1BT

SLV-10BT

Model Number	Item Description	Dimensions H x W x D
SLV-H-1CL	Coffee Sleeve Dispenser Clear Acrylic	10" x 6½" x 4½"
SLV-H-1BT	Coffee Sleeve Dispenser Black Polystyrene	10" x 6½" x 4½"
SLV-10BT	Spring Loaded Coffee Sleeve Dispenser - Black Polystyrene	12" x 5¾" x 3¾"

SLV SERIES COFFEE SLEEVE DISPENSERS

These countertop units provide a simple and effective means for storing and dispensing coffee sleeves. The SLV-10BT features a spring loaded design with suction cup feet and can be used in both horizontal and vertical dispensing applications.

▽ ICE CREAM CONE DISPENSERS

Replacement baffle plates are available for all cone dispenser models. Contact a **DISPENSE-RITE** representative for more details and proper sizing.

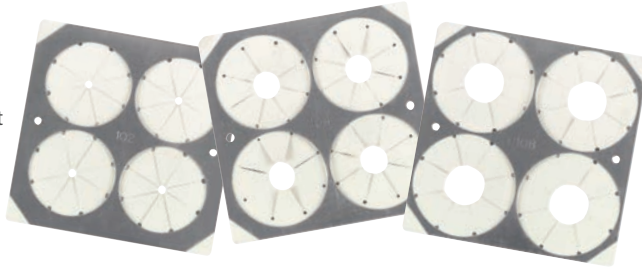

102B

104B

108B

Model Number	Item Description	Dimensions H x W x D
BCDS-BFL	One-Size-Fits-All Boxed Cone Dispenser Stand	15½" x 9" x 11¼"
102B	Small Replacement Baffle for use with BCDS-BFL	6" x 6" x ⅛"
104B	Medium Replacement Baffle for use with BCDS-BFL	6" x 6" x ⅛"
108B	Large Replacement Baffle for use with BCDS-BFL	6" x 6" x ⅛"



The CTCD-3BT is for use in countertop applications. The 705-DS is for use in angled surface mounted applications and includes mounting hardware.

CTCD-3BT

705-DS

705-DB

Model Number	Item Description	Dimensions H x W x D
CTCD-3BT	Countertop Black Polystyrene Cone Dispenser - Flat Bottom Cake Cones	21¾" x 6" x 22¾"
705-DS	30° Side Mount Stainless Steel Cone Dispenser - Flat Bottom Cake Cones	11¼" x 4¼" x 31"
705-DB	Replacement Baffle for use with 705-DS or CTCD-3BT	11⅞" x 4" x ⅛"

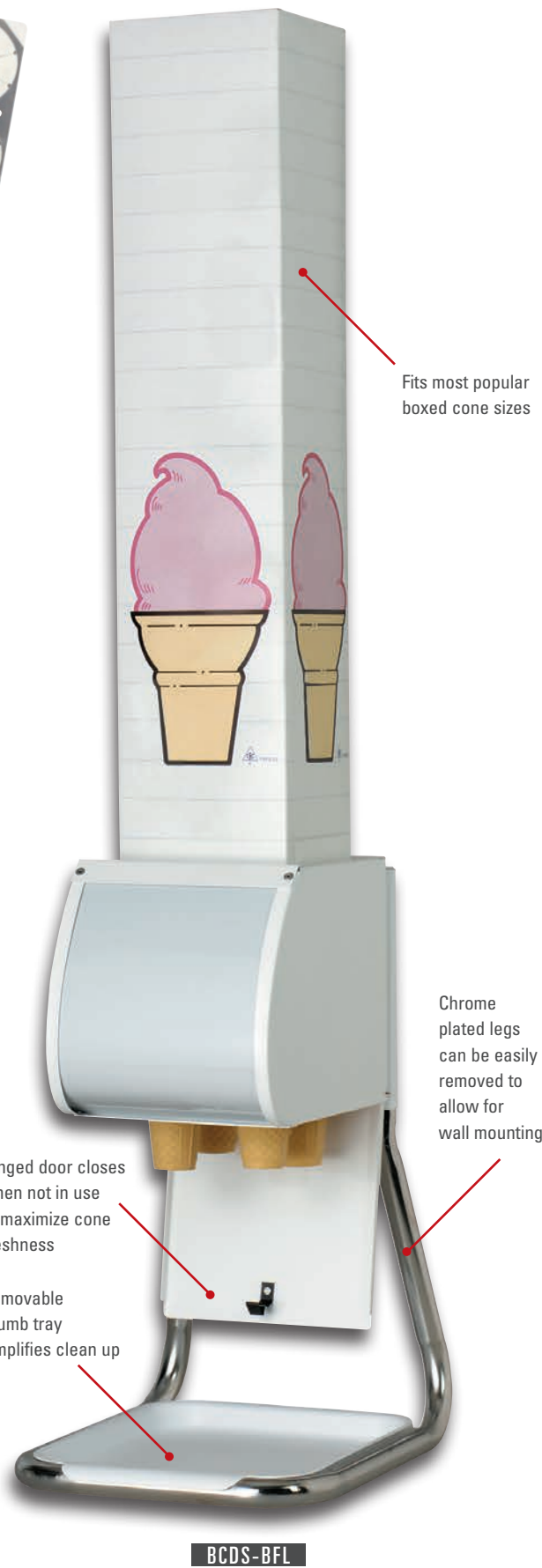

Fits most popular boxed cone sizes

Chrome plated legs can be easily removed to allow for wall mounting

Hinged door closes when not in use to maximize cone freshness

Removable crumb tray simplifies clean up

BCDS-BFL

▽ ICE CREAM CONE DISPENSERS & HOLDERS

Model Number	Item Description	Dimensions H x W x D
GFCD-1	Surface Mounted Gravity Fed Cone Dispenser for Cones 1½"–2¼"	31" x 3½"
GFCD-1-BFL	Replacement Baffle for use with GFCD-1	3½" x 5⁄8"
GFCD-2	Surface Mounted Gravity Fed Cone Dispenser for Cones 2¾"–3⁵⁄₁₆"	31" x 4¼"
GFCD-2-BFL	Replacement Baffle for use with GFCD-2	4¼" x 5⁄8"



GFCD-1



GFCD-2



GFCD-1-BFL

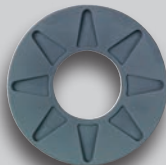

GFCD-2-BFL

Replacement baffles are available for both GFCD Series Cone Dispensers.



CSG-5L

CTCS-4C

CTCS-6C

CTCS-9C

TD-4

Model Number	Item Description	Dimensions H x W x D
CSG-5L	Acrylic Cone Stand with Guard – (5) 2" Holes	16" x 19" x 5½"
CTCS-4C	Acrylic Cone Stand (4) 1½" Holes	5" x 8" x 6¼"
CTCS-6C	Acrylic Cone Stand (6) 1½" Holes	5" x 9¾" x 6¼"
CTCS-9C	Acrylic Cone Stand (9) 1½" Holes	5" x 9¾" x 9¼"
TD-4	Acrylic 4 Section Topping Dispenser	5½" x 13½" x 8"

CLEAR PLASTIC CONSTRUCTION

▽ SPECIFICATIONS FOR IN-COUNTER CUP DISPENSERS

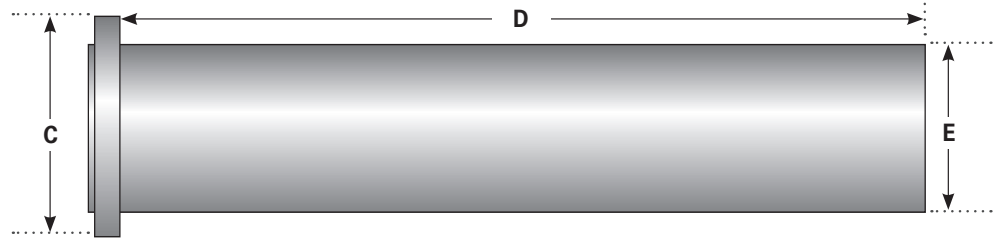
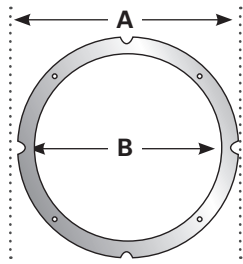

ONE-SIZE-FITS-ALL	NSF. MODEL NO.	A	B	C	D	E	CUP RIM
		MOUNTING BRACKET OUTSIDE DIAMETER	MOUNTING BRACKET CUT OUT	RING BEZEL DIAMETER	UNDER COUNTER LENGTH	TUBE DIAMETER	DIAMETER RANGE
▽ STL SERIES IN-COUNTER ABS PLASTIC ONE-SIZE-FITS-ALL ADJUSTABLE CUP DISPENSERS							
✓	STL-2	7" 178mm	5¼" 134mm	7⅞" 181mm	22" 559mm	5" 127mm	3⅞" – 4½" 79 – 114mm
✓	STL-2S	7" 178mm	5¼" 134mm	7⅞" 181mm	17" 432mm	5" 127mm	3⅞" – 4½" 79 – 114mm
✓	STL-2L	7" 178mm	5¼" 134mm	7⅞" 181mm	28" 711mm	5" 127mm	3⅞" – 4½" 79 – 114mm
▽ SLR SERIES IN-COUNTER ABS PLASTIC INTERCHANGEABLE BAFFLE CUP DISPENSERS							
	SLR-1	6" 153mm	4½" 114mm	6⅞" 156mm	22" 559mm	4¼" 108mm	2½" – 3⅞" 64 – 98mm
	SLR-1S	6" 153mm	4½" 114mm	6⅞" 156mm	17" 432mm	4¼" 108mm	2½" – 3⅞" 64 – 98mm
✓	SLR-2	7" 178mm	5¼" 134mm	7⅞" 181mm	22" 559mm	5" 127mm	3" – 4½" 77 – 114mm
✓	SLR-2S	7" 178mm	5¼" 134mm	7⅞" 181mm	17" 432mm	5" 127mm	3" – 4½" 77 – 114mm
✓	SLR-2L	7" 178mm	5¼" 134mm	7⅞" 181mm	28" 711mm	5" 127mm	3" – 4½" 77 – 114mm
▽ ADJ SERIES IN-COUNTER STAINLESS STEEL ADJUSTABLE CUP DISPENSERS							
	ADJ-1	5¼" 127mm	4" 102mm	5⅝" 137mm	22" 559mm	3⅛" 94mm	2½" – 3½" 64 – 89mm
	ADJ-1.50	5½" 140mm	4½" 114mm	5⅝" 143mm	22" 559mm	4⅛" 103mm	3" – 3⅞" 77 – 98mm
✓	ADJ-2	6¾" 172mm	5¼" 134mm	6⅞" 175mm	22" 559mm	4⅞" 124mm	3" – 4⅝" 77 – 118mm
✓	ADJ-2S	6¾" 172mm	5¼" 134mm	6⅞" 175mm	19" 483mm	4⅞" 124mm	3" – 4⅝" 77 – 118mm
	ADJ-3	7¼" 184mm	5¼" 146mm	7⅞" 187mm	22" 559mm	5½" 140mm	4½" – 5¼" 114 – 133mm
▽ BFL SERIES IN-COUNTER STAINLESS STEEL INTERCHANGEABLE BAFFLE CUP DISPENSERS							
✓	BFL-2	6¾" 172mm	5¼" 134mm	6⅞" 175mm	22" 559mm	4⅞" 124mm	3" – 4½" 77 – 114mm
✓	BFL-2S	6¾" 172mm	5¼" 134mm	6⅞" 175mm	19" 483mm	4⅞" 124mm	3" – 4½" 76 – 114mm
	BFL-3	7¼" 184mm	5¼" 146mm	7⅞" 187mm	22" 559mm	5½" 140mm	4½" – 5¼" 114 – 133mm

ONE YEAR LIMITED WARRANTY

Diversified Metal Products, Inc. warrants its products to the original purchaser to be free from defects in materials and workmanship under normal use and service.

Its obligation under this warranty shall be limited to repairing or replacing any part of the product, F.O.B. factory, which proves defective within one (1) year from date of sale, and which Diversified Metal Products, Inc.'s examination, discloses to its satisfaction to be thus defective.

No claims will be accepted for any part becoming defective due to damage in transit, improper installation, improper storage, misapplication, abuse, misuse, neglect, vandalism, alteration, accident, fire or other casualty, or act of nature.

Diversified Metal Products, Inc. cannot assume any responsibility for labor, freight cost, taxes, replacement parts purchased, normal maintenance, calibration or adjustments, or any other expense incurred outside of our factory.

TERMS AND CONDITIONS OF SALE

1. Minimum order for established accounts will be \$50.00 Net. A \$10.00 handling charge will be applied on all orders under the minimum order. Broken case charges apply. New accounts require a \$200 minimum order for setup. Valid state resale certificate(s) are required for all accounts. Please consult with a **DISPENSE-RITE** representative for more details.
2. Domestic Orders: Net 30 days from date of invoice.
International Orders: Please consult factory for payment terms.
3. Freight charges for all UPS and FedEx shipments are calculated based on dimensional weight and not physical weight. For products that must be double packed the shipping weight is calculated based on the outer carton dimensions.
4. Next day and second day air shipments must be received by 12:00 p.m. CST to ship that day.
5. Shipments are F.O.B. Northbrook, IL.
6. Returned Goods: Request to return goods must be made within 90 days of the invoice date. All returned goods must have a Return Merchandise Authorization (RMA) number issued by a **DISPENSE-RITE** representative. A Credit Memo to be applied to future purchases will be issued on all returned goods. All returns are subject to a 25% re-stocking charge. All goods must be unused and shipped prepaid in the original packaging materials. Goods must be received within 30 days of the RMA number issue date.
7. Custom or non-standard products (including ECL Series cup dispensers) may not be returned under any circumstances.
8. Specifications & pricing subject to change without notice. All weights and measurements shown herein are approximate.

CONTACT US

To speak with a customer service representative call toll-free 1-800-772-2877. Visit our website www.dispense-rite.com for additional information.

NEW PRODUCTS

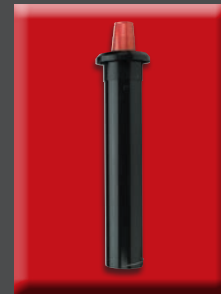

SLR-1 Series, pages 10-11



MCDC Series, pages 16-17



SLR-LID Series, pages 34-35



SLR-SCL-1BT, page 47

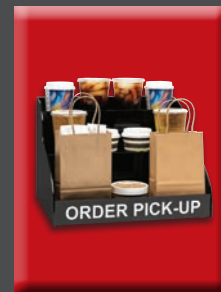

MOPU-1B, page 57



PCH-4B, page 66



DISPENSE-RITE®

MANUFACTURED BY:

Diversified Metal Products, Inc.
2205 Carlson Drive
Northbrook, IL 60062

TOLL-FREE

800-772-2877

PHONE

847-753-9595

FAX

847-753-9648

WEBSITE

www.dispense-rite.com



DISPENSE-RITE®

Diversified Metal Products, Inc.

2205 Carlson Drive | Northbrook, IL 60062

toll free 800-772-2877 | phone 847-753-9595 | fax 847-753-9648

www.dispense-rite.com | sales@dispense-rite.com

DISPENSE-RITE is pleased to offer the world's largest selection of dispensing products. We offer a complete selection of products for cups, lids, straws, condiments, napkins, coffee sleeves, flatware, bottles and ice cream cones.



PROUDLY MADE IN USA

